

15 Control technology and software



- + Pneumatic and electropneumatic controllers
- + Electronic controllers with serial and Ethernet interfaces
- + Electrical peripherals: electric components for valve terminals and AS-Interface components
- + Display and operating units for controls and electrical terminals
- + Software

Highlights



CECC

Controllers

- + Compact programmable logic controllers
- + Programming with CODESYS to IEC 61131-3

Page 1178



CPX

Terminal



- + Automation platform
- + Open to all common fieldbus protocols and Ethernet

Page 1184

Table of contents

Product overview	1172
Controller CECC	1178
Terminal CPX	1184





Pneumatic and electropneumatic controllers

Type	 Pulse generator TAA, TAB	 Memory module SBA2N	 Pulse generator VLG
Pneumatic port	Barbed connections for 3 mm plastic tubing NW3	Barbed connections for 3 mm plastic tubing NW3	G1/8, G1/4
Type of mounting	On mounting frame	On mounting frame	Through-hole in housing
Nominal size	2 mm	3 mm	3.5 mm, 7 mm
Standard nominal flow rate	60 l/min	70 l/min	120 l/min, 600 l/min
Description	<ul style="list-style-type: none"> For ensuring a logical program sequence Poppet valve with integrated AND as well as OR element 	<ul style="list-style-type: none"> For input logic operations For simplifying the design and installation of pneumatic controllers 	<ul style="list-style-type: none"> For generating infinitely adjustable signals in controllers For high-speed cylinder movements of diaphragm cylinders, single and double-acting diaphragm cylinders
→ Page/online	taa	sba	vlg



Software tool

CODESYS	 CODESYS The IEC 61131-3 Programming System provided by Festo	CODESYS for standardised programming of embedded devices to IEC 61131-3. It makes your life easier with simple commissioning, fast programming and parameterisation.	<ul style="list-style-type: none"> The IEC 61131-3 standard means that CODESYS is flexible and open for all types of control tasks. Modular: offline and online functions as well as components for hardware configuration and visualisation User-friendly IEC function block extension Re-use of existing application parts
Advantages	<ul style="list-style-type: none"> Hardware-neutral software platform for quick and easy configuration, programming and commissioning of pneumatic and electric automation solutions Extensive module libraries for single or multi-axis positioning motions 	<ul style="list-style-type: none"> The CODESYS parameterisation software can be found on the website under Support > Support Portal > enter search term. 	



Electronic controllers

Type	 Controller CECC-D, CEDD-LK, CEDD-S	 Controller CECX-X-M1, CECX-X-C1	 Input/Output module CECX-D-E8A, CECX-A4E4A	 Input module CECX-D16E, CECX-A4E-V, CECX-E-E-T-P
Operating voltage	19.2 ... 30 V DC	19.2 ... 30 V DC	19.2 ... 30 V DC	19.2 ... 30 V DC
CPU data	400 MHz processor	64 MB DRAM, 400 MHz processor	64 MB DRAM, 400 MHz processor	64 MB DRAM, 400 MHz processor
Type of fieldbus interface	CAN bus	CAN bus		
Ethernet, connector plug	RJ45	8-pin, socket, RJ45		
Description	<ul style="list-style-type: none"> Compact programmable logic controller Programming with CODESYS to IEC 61131-3 12 digital inputs, 8 digital outputs, two high-speed counters up to 250 kHz Ethernet 10/100 Mbit/s USB interface for data transfer CECC-LK with CANopen, I/O link, I-Port and Modbus TCP protocol 	<ul style="list-style-type: none"> Modular master controller with CODESYS or motion controller with CODESYS and SoftMotion. Programming to standard IEC 61131-3 Three plug-in slots for optional modules Optional: communication module for PROFIBUS 	<ul style="list-style-type: none"> Digital modules: 6 or 8 digital inputs and 8 digital outputs Analogue modules for voltage: 4 analogue voltage inputs and 4 analogue voltage outputs Analogue modules for current: 4 analogue current inputs and 4 analogue current outputs Address setting function, short circuit monitoring function for outputs, debounce function, interrupt function, sensor failure detection function 	<ul style="list-style-type: none"> Digital modules: 16 digital inputs Analogue modules for voltage: 4 analogue voltage inputs Temperature input modules: 4 or 6 temperature inputs
→ Page/online	1178	cecx-x-m1	cecx	cecx





Electronic controllers

			
Type	Output module CECX-D14A2, CECX-A4A-V	Encoder interface CECX-C2G	Fieldbus interface CECX-F-PB-S-V, CECX-F-PB-V1, CECX-B-CO
Operating voltage	24 VDC +25% /-15%	19.2 ... 30 V DC	
CPU data			
Type of fieldbus interface			CAN Bus, PROFIBUS master DP-V1, PROFIBUS slave DP-V0, PROFIBUS slave DP-V1
Ethernet, connector plug		9-pin, socket, RJ45	8-pin, socket, 9-pin, plug
Description	<ul style="list-style-type: none"> Digital modules: 14 digital outputs Analogue modules: 4 analogue voltage outputs 	<ul style="list-style-type: none"> Distance measurement function Pulse counter Speed measurement function Shaft encoder monitoring function Counter reading latch function Sensor break monitoring Status display function 	<ul style="list-style-type: none"> PROFIBUS-Master DP-V1 Connection via CAN Bus to the modular controller For connecting decentralised peripheral modules in series
→ Page/online	cecx	cecx	cecx





Electronic controllers

		
Type	Electrical interface CECX-C, CECX-S	AS-i module CESA
Operating voltage		AS-i voltage 30 VDC
CPU data		
Type of fieldbus interface		CANopen Device Specification CiA DS-301, PROFIBUS to DIN 19245 Part 3
Ethernet, connector plug	9-pin, plug	
Description	<ul style="list-style-type: none"> For extending the controller with two RS232 serial interfaces 	<ul style="list-style-type: none"> AS-i master gateway Duplicate address recognition Direct operation by pushbuttons Graphical display Comprehensive diagnostics via LED and display Specification 3.0
→ Page/online	cecx	cesa





Electrical peripherals

Type	 Terminal CPX-P	 Input module CTSL	 Bus node CTEU	 CP installation system CTEC
Max. no. of inputs	Digital 512, analogue 32	16	128	128
Max. no. of outputs	Digital 512, analogue 32		128	128
No. of module positions	Max. 9 electric		32	Max. 4 installation strings, max. 4 CP modules per string
Electrical actuation	Fieldbus, integrated controller	IO-Link, I-Port	CANopen, DeviceNet, CC-Link, PROFIBUS, EtherCAT, I-Port	Fieldbus, integrated controller
Description	<ul style="list-style-type: none"> Use of matching remote I/O and valve terminals in a control cabinet Unique modular structure Comprehensive integrated diagnostic and maintenance function Combination with modules of the electrical terminal CPX, which enables use for hybrid applications 	<ul style="list-style-type: none"> For installation system CTEL For recording sensor input signals Display of the input statuses for each input signal via an assigned LED Diagnostic LED for short circuit/overload of sensor supply 	<ul style="list-style-type: none"> For valve terminals VTUB-12, VTUG, MPA-L, CPV, VTOC Can be expanded into installation systems CTEL Fieldbus-typical LEDs, interfaces and switching elements available Isolated power supply for electronics and valves 	<ul style="list-style-type: none"> CPX Master module for four CPI strings Combination of centralised and decentralised installation possible Decentralised pneumatic components and sensors for fast processes Can be connected to valve terminal CPV, MPA-S, CPV-SC
→ Page/online	cpx-p	ctsl	cteu	ctec



Electrical peripherals

Type	 Terminal CPX	 Electrical interface CPX-CTEL	 Measuring module CPX-CMIX	 AS-Interface® components ASI
Max. no. of inputs	Digital 512, analogue 32	256		496
Max. no. of outputs	Digital 512, analogue 18	256		496
No. of module positions	Max. 9 electric input/output modules	Max. 4 modules with I-Port interface	9	
Electrical actuation	Fieldbus, integrated controller	I-Port		AS-Interface
Description	<ul style="list-style-type: none"> Automation platform Choice of plastic or metal housing with individual linking Open to all common fieldbus protocols and Ethernet Integrated diagnostic and maintenance functions Applicable as stand-alone remote I/O or with valve terminals MPA-S, MPA-L, VTSA/VTSA-F 	<ul style="list-style-type: none"> Fig. 1: CPX-CTEL Master module with 4 I-Port connections Decentralised point-to-point connection to input modules and/or valve terminals possible Standardised M12 connections 	<ul style="list-style-type: none"> Pneumatics and electrics – moving and measuring on one platform Innovative measurement technology – piston rod drives, rodless drives, rotary drives Actuation via fieldbus Remote maintenance, remote diagnostics, web server, SMS and e-mail alert are all possible via TCP/IP Modules can be quickly exchanged and expanded without altering the wiring 	<ul style="list-style-type: none"> Accessories for AS-Interface installation system Modules for actuating individual valves ASI-EVA Cable distributor ASI-KVT Addressing device ASI-PRG-ADR Compact I/O modules (IP65, IP67) AS-Interface power supply unit SVG
→ Page/online	1184	cpx-ctel	cpx-cmix	as-interface





Operator units

Type	 Operator unit, touchscreen CDPX	 Simulator CDSM	 Operator unit, touchscreen CDSA	 Operator unit, text-based FED-50
Display	Colour TFT		Colour TFT	Monochrome LCD, with backlighting
Display size	4.3", 7", 10.4", 13.3"		6.5"	4 x 20 characters
Recipe memory	32 KB			16 KB
Display resolution	480x272 pixels, SVGA, 800x600 pixels, WVGA, 800x480 pixels, WXGA, 1280x800 pixels		VGA, 640x480 pixels	120x32 pixels
Ethernet interface	RJ45 10/100 MBd		2nd Ethernet interface optional 10 MBd, RJ45 10/100 MBd	Optional, 10 MBd
No. of user LEDs				5
No. of function keys			31	7
Description	<ul style="list-style-type: none"> Powerful processors combined with wide-screen technology Remote access, remote control FTP and HTTP servers Open for web and multimedia applications 	<ul style="list-style-type: none"> Straightforward design of human-machine dialogues Semi-graphical display of process values makes them easier to read Suitable for commissioning the following motor controllers: CMMO-ST, CMMP-AS, CMMS-ST To simulate input and output signals during commissioning 	<ul style="list-style-type: none"> Interfaces for Ethernet, RS-422-A/RS-232-C, USB host/USB client Versions with colour touchscreen 	<ul style="list-style-type: none"> Straightforward design of human-machine dialogues Semi-graphical display of process values makes them easier to read 4-line text display and operating buttons Serial interface Recipe handling Password protection
→ Page/online	cdpx	cdsm	cdsa	fed



Operator units

Type	 Operator unit, touchscreen FED-770, FED-3000	 Operator unit, text-based CPX-MMI
Display	Colour TFT	LCD display, with backlighting
Display size	13.3", 7"	128 x 64 pixels
Recipe memory	32 KB	
Ethernet interface	RJ45 10/100 MBd	
No. of user LEDs	1 ... 5	
No. of function keys		3
Description	<ul style="list-style-type: none"> Graphics-capable for maximum flexibility when displaying processes and data No programming effort in the PLC program Convenient FED Designer WYSIWYG design tool Shorter project planning thanks to re-usable objects Trend display Program sequences display Can be connected to all FEC® units Extremely sturdy thanks to metal housing 	<ul style="list-style-type: none"> Data polling, configuration and diagnostic functions for terminal CPX 3 function keys, 4 arrow keys Connection to the CPX bus nodes or control block via a pre-assembled M12 cable
→ Page/online	fed	1195

Software

Type	 Operator package GSIB	 Operator package P.BP	 Software GSPF	 Software and manual P.SW
Description	<ul style="list-style-type: none"> Information software and documentation for motor controllers CMMP-AS, CMMS-ST The operator package contains a CD-ROM with user documentation for motor controller and configuration software FCT (Festo Configuration Tool) and a brief description 	<ul style="list-style-type: none"> Information software and documentation for motor controllers CMMP-AS and SFC-DC, handling module HSP/HSW and motor unit MTC-DCI The operator package contains a CD-ROM with user documentation for motor controller and configuration software FCT (Festo Configuration Tool) and a brief description 	<ul style="list-style-type: none"> Programming software and documentation for motor controller CMMP-AS with additional functions for cam disc functionality Software for configuring, programming, commissioning and maintaining the controller CECC Programming software for creating custom application programs for safety systems CMGA Operating software for configuring, programming and for AS-Interface diagnostics with serial connecting cable The software package contains a CD-ROM with user documentation for the motor controller 	<ul style="list-style-type: none"> For configuring the terminal CPX, for parameterising the CPX modules, for programming the controller CPX-FEC Software for checkbox CHB-C for image evaluation, display, protocol and adaptation of the I/O parameters Software for Checkbox CHB-C for the complete analysis of recognition processes
→ Page/online	gsib	software	gspf	software

Software

Type	 Software licence GSLO	 Software (FluidDraw S5®) GSWF-S5	 Software (FluidDraw P5®) GSWF-P5
Description	<ul style="list-style-type: none"> For enabling tools on the Compact Vision System SBOC-Q/SBOI-Q 	<ul style="list-style-type: none"> Quick and easy creation of pneumatic circuit diagrams Extensive library of pneumatic symbols Easy, user-friendly operator guidance Interface to Festo products (catalogue, online shop) 	<ul style="list-style-type: none"> Quick and easy creation of pneumatic circuit diagrams Comprehensive library of pneumatic and electrical symbols User-specific product databases and translation tables Terminal plans, cable diagrams, cable lists, parts lists Dimensioning function for preparing simple control cabinet and system layouts Consistent equipment identification Multi-level project tree
→ Page/online	gslo	gswf-s5	gswf-p5

Documentation

	
Type	Manuals GDCW, GDCP, GDCC, GSIB, P.BE, P.BP
Description	<ul style="list-style-type: none"> • For software • For control blocks • For motors and controllers • For valve terminals and electrical peripherals • For vision systems
→ Page/online	Documentation

Learning systems

	
Type	EduTrainer® D
Description	<ul style="list-style-type: none"> • PLC EduTrainer® support system for use in teaching and training • Equipped with PLCs from different manufacturers • Two series: Universal and Compact • Equipped with 19" simulation modules • Individually configurable or pre-assembled
→ Page/online	edutrain



Overview/Configuration/Ordering
 → www.festo.com/catalogue/cecc



Additional information/Support/User documentation
 → www.festo.com/sp/cecc

Electronic controllers
 Controllers

CECC



- + Modern, compact and versatile controller
- + Programming with CODESYS to IEC 61131-3
- + 12 digital inputs, 8 digital outputs, additionally 2 high-speed counters up to 250 kHz
- + Ethernet 10/100 Mbit/s
- + USB interface for transferring data
- + CECC-LK with CANopen, IO-Link, I-Port and Modbus TCP protocol



- Compact controller with 400 Mhz processor
- CODESYS provided by Festo
- 12 digital inputs
- 8 digital outputs

→ www.festo.com/catalogue/cecc

Application

Controller



The controllers CECC are modern, compact and versatile controllers that enable programming with CODESYS according to IEC 61131-3.

State-of-the-art programming

CODESYS V3 pbF offers a user-friendly interface with the following new functions:

- Object-oriented programming
- Modern editors for simplified input
- Simplified configuration for fieldbus

- New configurator for IO-Link Master



- Multiple controllers in one project
- Improved troubleshooting function
- Simplified project navigation

Basic functions of the CECC-D

The controllers CECC (CECC-D) offer the following basic functions:

- 12 digital inputs, 8 digital outputs, additionally 2 high-speed counters up to 250 kHz
- Ethernet 10/100 Mbps, Modbus TCP client/server, EasyIP, TCP/IP, OPC server available

- CANopen master: connection of the electric drives
- USB interface for data transfer
- Can be connected directly with modern HMI devices: CDPX

Additional functions CECC-LK

- This variant of the CECC offers four IO-Link masters and one IO-Link device interface
- The integrated IO-Link interface of the CECC-LK enables quick and easy connection of Festo valve terminals and sensors to a controller

- All modern, compact valve terminals from the CTEU series can be connected to IO-Link masters: VTUB, VTUG, MPA, CPV, VTOC and upcoming devices, as well as the input box CTSL

Additional functions of the CECC-S

- 2 RS232 interfaces
- 1 RS422/RS485 interface, allows freely configurable communication with different devices
- The RS422 interface can optionally be used as an encoder interface. For this operating mode, there are numerous setting options on the encoder type, comparison functions and referencing
- In addition, the CECC offers an IO-Link master and an IO-Link device interface

Fieldbus interfaces

The CECC-LK and CECC-S can be connected to a combination of CTEU nodes and CAPC on various fieldbuses via the IO-Link device interface:

- PROFIBUS
- EtherCAT
- DeviceNet
- CANopen
- AS-interface



System configuration

The CECC can communicate with all electric drive controllers from Festo and actuate all valve terminals via CANopen. The CECC communicates via Ethernet with other controllers and operator units from Festo, such as the modern, new HMI device series CDPX and the camera SBOX-Q for image evaluation.

Data sheet

**Technical data**

CPU data	400 MHz processor
Degree of protection	IP20
Status displays	LED
Electrical connection technology for I/O	Socket strip, grid 3.5 mm

Digital inputs

Number	12
Switching logic	Positive logic (PNP)
High-speed clock pulse inputs	2, each with max. 180 kHz
Input signal delay [ms]	Typically 3
Input voltage [V DC]	24
Permissible connecting cable length [m]	30

Digital outputs

Number	8
Switching logic	Positive logic (PNP)
Contact	Transistor
Output voltage [V DC]	24
Output current [mA]	500
Switching frequency [kHz]	Max. 1
Protection against short circuit	Yes

Serial interfaces

USB interface	USB 1.1 for connecting external storage media
Ethernet interface	RJ45 for connecting external operator units
IO-Link interface	Cage Clamp, master 5-pin
Fieldbus interface	
Programming software	CODESYS provided by Festo
Fieldbus interface type	CAN bus, master
Connection technology	Sub-D plug, 9-pin
Transmission rate [kbps]	125, 250, 500, 800, 1000 Adjustable via software

Operating and environmental conditions		CECC-LK	CECC-D	CECC-S
Operating voltage [V DC]		19.2 ... 30		20.4 ... 30
Current consumption at 24 V DC [mA]		100		
Ambient temperature [°C]		0 ... +55		

Order code

		CECC			
Type					
CECC					
Function module					
LK	With 14 digital inputs and 8 digital outputs, Ethernet, USB, CANopen, 4 IO-Link masters, 1 IO-Link device				
D	With 14 digital inputs and 8 digital outputs, Ethernet, USB, CANopen				
S	With 14 digital inputs and 8 digital outputs, Ethernet, USB, CANopen, 2 RS232, 1 RS485/RS422/encoder, 1 IO-Link master, 1 IO-Link device				

Order example:

CECC-LK

Function module CECC-LK, with 14 digital inputs and 8 digital outputs, Ethernet, USB, CANopen, 4 IO-Link masters, 1 IO-Link device

Ordering – Product options

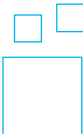
	Configurable product	This product and all its options can be ordered using the configurator.	The configurator can be found under Products on the DVD or → www.festo.com/catalogue/...	Enter the type code in the search field.
--	-----------------------------	--	--	--



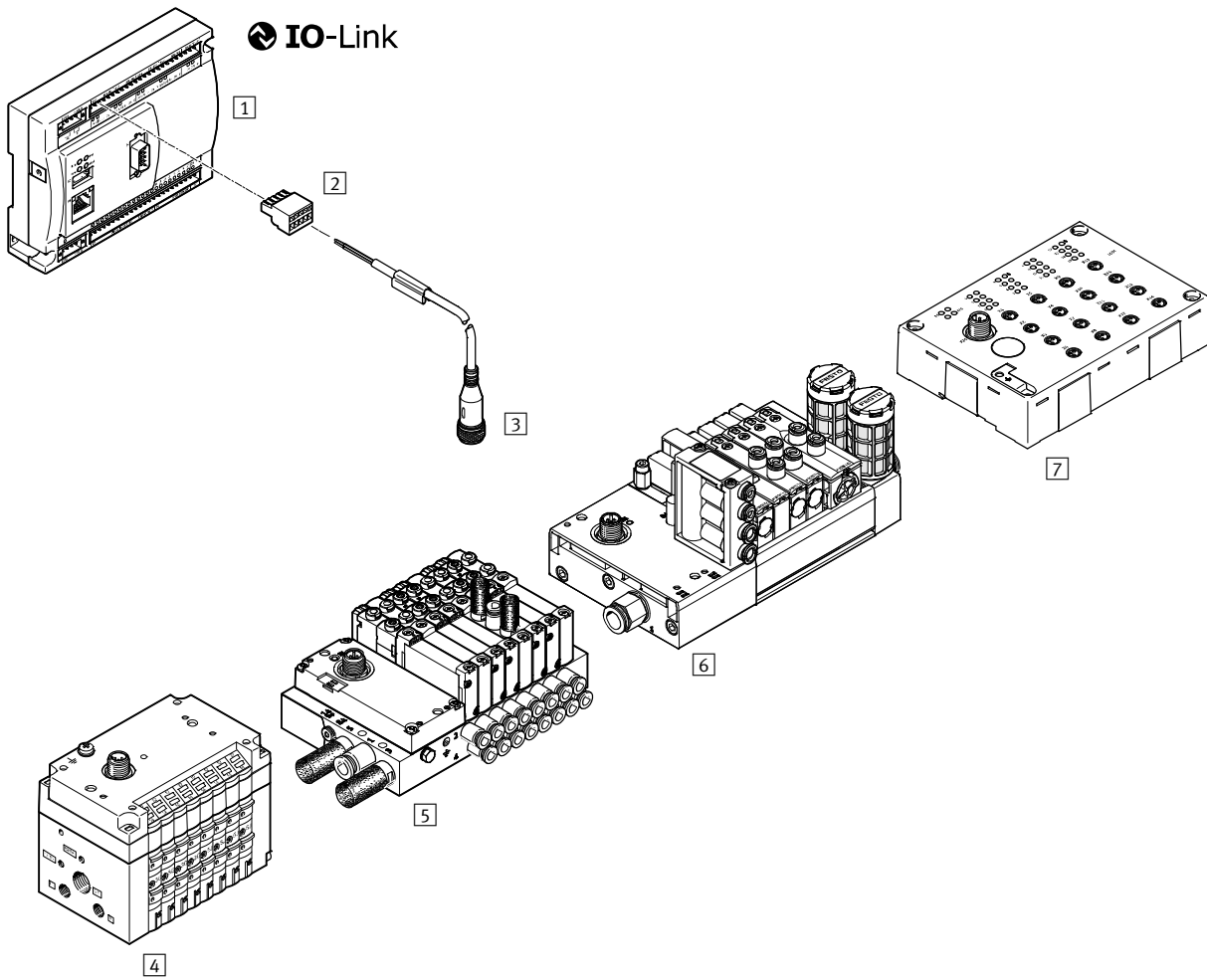



Accessories

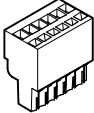

		→ Page/ online
1	Controller CECC	1180
2	Plug NECC	1183
3	Connecting cable NEBU	1183
4	Valve terminal CPV	cpv

		→ Page/ online
5	Valve terminal VTUG	vtug
6	Valve terminal VTUB	vtub
7	Input module CTSL	ctsl
-	CODESYS V3 software	1183

Accessories – Ordering data

	Description	Part no.	Type
2 Plug			
	–	575303	NECC-L2G4-C1-M
	2-pin	575302	NECC-L2G2-C1
	4-pin	8024782	NECC-L2G4-C1
	5-pin	575304	NECC-L2G5-C1
	6-pin	575305	NECC-L2G6-C1
	8-pin	575306	NECC-L2G8-C1
	24-pin	575307	NECC-L2G24-C1
	9-pin	576031	NECC-S1G9-C2-M
3 Connecting cables			Technical data → 1161
	Straight socket, 5-pin, cable length 2.5 m	541330	NEBU-M12G5-K-2,5-LE5
	Angled socket, 5-pin, cable length 2.5 m	567843	NEBU-M12W5-K-2,5-LE5
	Up to 20 m can be used ¹⁾	★	574321 NEBU-M12G5-E-5-Q8-M12G5
		★	574322 NEBU-M12G5-E-7,5-Q8-M12G5
		★	574323 NEBU-M12G5-E-10-Q8-M12G5
Programming software			
	–	542000	GSPF-CDS-3

1) Modular product, additional information → Internet: nebu



Overview/Configuration/Order
→ www.festo.com/catalogue/cpx



Additional information/Support/User documentation
→ www.festo.com/sp/cpx

Electrical peripherals

Terminal

CPX



- + Centralised, decentralised, hybrid installation system with maximum modularity and flexibility
- + IP65, IP67 or IP20
- + Choice of polymer or metal housing with individual linking
- + Open to common fieldbus protocols and Ethernet
- + Integrated diagnostic and service function
- + Operating modes: stand-alone as remote I/O or with valve terminals MPA, VTSA/VTSA-F



- Open to all leading fieldbus protocols/Industrial EtherNet with integrated IT services such as SMS/e-mail alert, web monitor
- Unique modular structure
- Comprehensive integrated diagnostic and maintenance functions
- CPX as a dedicated remote I/O
- CPX controls valve terminal MPA-L, VTSA
- Can be programmed with integrated controller

→ www.festo.com/catalogue/cpx

Product range overview

Type	Designation	Code ¹⁾	Address space		Version		→ Page/ online
			Inputs	Outputs	Polymer	Metal	
CPX-FEC-1-IE	Front End Controller Remote	T03	512 bit	512 bit	■	–	1196
CPX-FEC-1-IE	Front End Controller Remote I/O	T05	512 bit	512 bit	■	–	cpx
CPX-CEC	CODESYS Embedded Controller	T06, T07, T08	512 bit	512 bit	■	–	cpx
CPX-CEC-V3	CODESYS V3 Embedded Controller	T32, T33, T34	512 bit	512 bit	■	–	1197
CPX-FB6	Bus node for INTERBUS	F06	96 bit	96 bit	■	–	1198
CPX-FB11	Bus node for DeviceNet	F11	512 bit	512 bit	■	–	1198
CPX-FB13	Bus node for PROFIBUS DP	F13	512 bit	512 bit	■	–	1199
CPX-FB14	Bus node for CANopen	F14	256 bit	256 bit	■	–	1199
CPX-FB20	Bus node for INTERBUS, fibre-optic connection	F20	96 bit	96 bit	–	■	cpx
CPX-FB21	Bus node for INTERBUS, fibre-optic connection	F21	96 bit	96 bit	–	■	cpx
CPX-FB23-24	Bus node for CC-Link	F23	256 bit	256 bit	■	–	1200
		F24	512 bit	512 bit	■	–	1200
CPX-FB32	Bus node for EtherNet/IP	F32	128 bit	128 bit	■	–	1200
CPX-FB33	Bus node for PROFINET RT, 2 x M12	F33	512 bit	512 bit	–	■	1201
CPX-M-FB34	Bus node for PROFINET RT, 2 x RJ45	F34	512 bit	512 bit	–	■	1201
CPX-M-FB35	Bus node for PROFINET RT, 2 x SCRJ push-pull, AIDA	F35	512 bit	512 bit	–	■	1202
CPX-FB36	Bus node for EtherNet/IP, 2 x M12	F36	512 bit	512 bit	■	–	cpx
CPX-FB37	Bus node for EtherCAT	F37	512 bit	512 bit	■	–	cpx
CPX-FB38	Bus node for EtherCAT	F38	512 bit	512 bit	■	–	1202
CPX-FB39	Bus node for Sercos III	F39	512 bit	512 bit	■	–	cpx
CPX-FB40	Bus node for POWERLINK	F40	512 bit	512 bit	■	–	cpx
CPX-M-FB41	Bus node for PROFINET RT, 2 x SCRJ push-pull, AIDA	F41	512 bit	512 bit	–	■	cpx

1) Code letter within the order code for a valve terminal configuration.

Note

The electrical terminal can be ordered quickly and easily online.
The convenient product configurator can be found at:

→ www.festo.com/catalogue/cpx

Note

The bus node and control block provide the aforementioned address space.

Product range overview

Type	Designation	Code ¹⁾	Address space		Version		→ Page/ online
			Inputs	Outputs	Polymer	Metal	
CPX-CP-4-FB	CP interface	T11 ... T18	16 ... 128 bit	16 ... 128 bit	■	–	1203
CPX-CTEL-4-M12-5POL	CPX CTEL master	T40 ... T44	0 ... 256 bit	0 ... 256 bit	■	–	1203
CPX-CTEL-2-M12-5POL-LK	CPX CTEL master, IO-Link	T45 ... T47	0 ... 192 bit	0 ... 192 bit	■	–	cpx
CPX-CMPX	End-position controller CMPX	T20	48 bit	48 bit	■	–	cpx
CPX-CMAX	Axis controller CMAX	T21	64 bit	64 bit	■	–	cmax
CPX-CMIX	Measuring module CMIX	T23	48 bit	48 bit	■	–	cpx
CPX-CM-HPP	FHPP gateway	T31	256 bit	256 bit	■	–	1204
CPX-4DE	Input module, 4 digital inputs	F	4/8 bit ²⁾	–	■	–	cpx
CPX-8DE	Input module, 8 digital inputs	E	8 bit	–	■	–	1204
CPX-8DE-D	Input module, 8 digital inputs (channel diagnostics)	D	8 bit	–	■	–	cpx
CPX-8NDE	Input module, 8 digital inputs (NPN)	O	8 bit	–	■	–	1204
CPX-16DE	Input module, 16 digital inputs	M	16 bit	–	■	–	1205
CPX-M-16DE-D	Input module, 16 digital inputs (channel diagnostics)	NM	16 bit	–	■	–	1205
CPX-L-16DE-16-KL-3POL	Input module, 16 digital inputs (spring-loaded terminal)	NB	16 bit	–	■	–	cpx
CPX-F8DE-P	PROFIsafe input module, 8 digital inputs for reliable detection and evaluation of input statuses	ND	48 bit	56 bit	■	–	cpx
CPX-4DA	Output module, 4 digital outputs	A	–	4/8 bit ²⁾	■	–	1205
CPX-8DA	Output module, 8 digital outputs	L	–	8 bit	■	–	cpx
CPX-8DA-H	Output module, 8 digital outputs (high current)	NL	–	8 bit	■	–	1206
CPX-8DE-8DA	Input/Output module, 16-way, 8 digital I/O each	Y	8 bit	8 bit	■	–	1207
CPX-L-8DE-8DA-16-KL-3POL	Input module, 8 digital inputs/outputs (spring-loaded terminal)	NC	8 bit	8 bit	■	–	cpx
CPX-2ZE2DA	Counter module, 2 digital inputs, 2 digital outputs	T25	96 bit	96 bit	■	–	cpx
CPX-2AE-U-I	Input module, 2 analogue inputs	U	32 bit	–	■	–	1208
CPX-4AE-U-I	Input module, 4 analogue inputs	NI	64 bit	–	■	–	cpx
CPX-4AE-I	Input module, 4 analogue inputs (current)	I	64 bit	–	■	–	1209
CPX-4AE-T	Input module, 4 analogue inputs (temperature)	T	64 bit	–	■	–	1210
CPX-4AE-TC	Input module, 4 analogue inputs (temperature, thermoelements)	NT	64 bit	–	■	–	1211
CPX-4AE-P	Input module, 4 analogue inputs (pressure)	NY, NV	64 bit	–	■	–	1212
CPX-2AA-U-I	Output module, 2 analogue outputs	P	–	32 bit	■	–	1213
CPX-FVDA-P2	PROFIsafe shut-off module	NG	48 bit	48 bit	–	■	1214
CPX-GP-03-4.0	Pneumatic interface to Midi/Maxi	–A	–	8 ... 32 bit	■	–	cpx
CPX-M-GP-03-4.0		–A	–	8 ... 32 bit	–	■	cpx
VMPA-FB-EPL	Pneumatic interface to MPA-S	–D	16 ... 512 bit	4 ... 512 bit	■	■	cpx
VMPAF-FB-EPL	Pneumatic interface to MPA-F	–F	16 ... 512 bit	4 ... 512 bit	■	■	cpx
VMPAL-EPL-CPX	Pneumatic interface to MPA-L	–L	–	4 ... 32 bit	■	–	1217
VABA-S6-1-X	Pneumatic interface to VTSA and VTSA-F	–S	–	8 ... 32 bit	■	■	1217
CPX-GP-CPA	Pneumatic interface to CPA	–B, –C	–	8 ... 24 bit	■	–	cpx

- 1) Code letter within the order code for a valve terminal configuration.
 2) Number of occupied bits is dependent on the upstream bus node/control block

Note

The electrical terminal can be ordered quickly and easily online.
 The convenient product configurator can be found at:

→ www.festo.com/catalogue/cpx

Note

Input/Output modules, etc. use the specified address space.

Features

Installation concept

- Choice of several valve terminal types for different applications:
 - MIDI/MAXI
 - CPA
 - MPA-S
 - MPA-L
 - VTSA/VTSA-F
- Economical from the smallest configuration up to the maximum number of modules
- Up to 9 electrical input/output modules plus bus nodes and pneumatic interface/electronics modules for valves
- Extensive range of functions and connection options for the electrical modules
- Choice of connection technology for technically and economically optimised connections
- Can be used as a dedicated remote I/O module

Electrics

- High operating voltage tolerance ($\pm 25\%$)
- Choice of M18, 7/8" or AIDA push-pull connection for power supply
- Open to all fieldbus protocols and Ethernet
- Optional function and technology modules for pre-processing
- IT services and TCP/IP such as remote maintenance, remote diagnostics, web server, SMS and e-mail alert
- Digital inputs and outputs, 4-way/8-way/16-way, optionally available with individual channel diagnostics
- Analogue inputs and outputs, 2-way/4-way
- Supply ports
- Temperature inputs
- Controllers for pneumatic and electric axes
- IP65 and IP67 or IP20

Mounting

- Wall or H-rail mounting, also on mobile units
- Conversions/extensions are possible at any time, individual linking with CPX metal design
- Modular system offering a range of configuration options
- Fully assembled and tested unit
- Lower selection, ordering, assembly and commissioning costs thanks to the central CPX terminal
- Choice of pneumatic components for optimised control chain system design
- Decentralised, subordinate CPI installation system improves cycle times by up to 30%
- Safe and convenient earthing thanks to earthing plate

Operation

- Fast troubleshooting thanks to an extensive selection of LEDs (some of which are multi-coloured) on the bus node and on all I/O modules
- Suitable for direct machine mounting (IP65/IP67) or in a control cabinet with a terminal connection (IP20)
- Supports module and channel-oriented diagnostics
- On-the-spot diagnostics in plain text via handheld device
- Fieldbus/Ethernet remote diagnostics
- Innovative diagnostic support with integrated web server/web monitor or maintenance tool with USB adapter for PC
- Optimised commissioning thanks to parameterisable functions
- Reliability of service with connection blocks and modules that are quick to replace without changing the wiring

Pneumatic variants of the CPX terminal

The electrical CPX terminal is a modular peripheral system for valve terminals. The system is specifically designed so

that the valve terminal can be adapted to suit different applications.

The modular system design lets you con-

figure the number of valves, inputs and additional outputs to suit the applica-

tion.

With valve terminal – decentralised

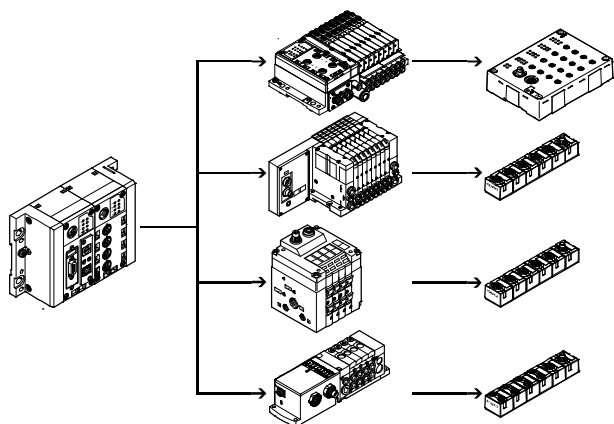

With valve terminal MPA-S – centralised

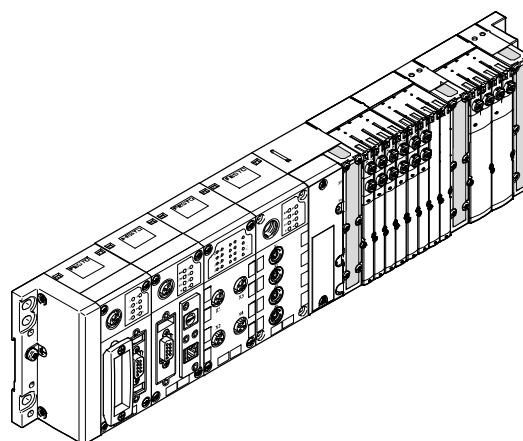

Variants

Complete overview of modules

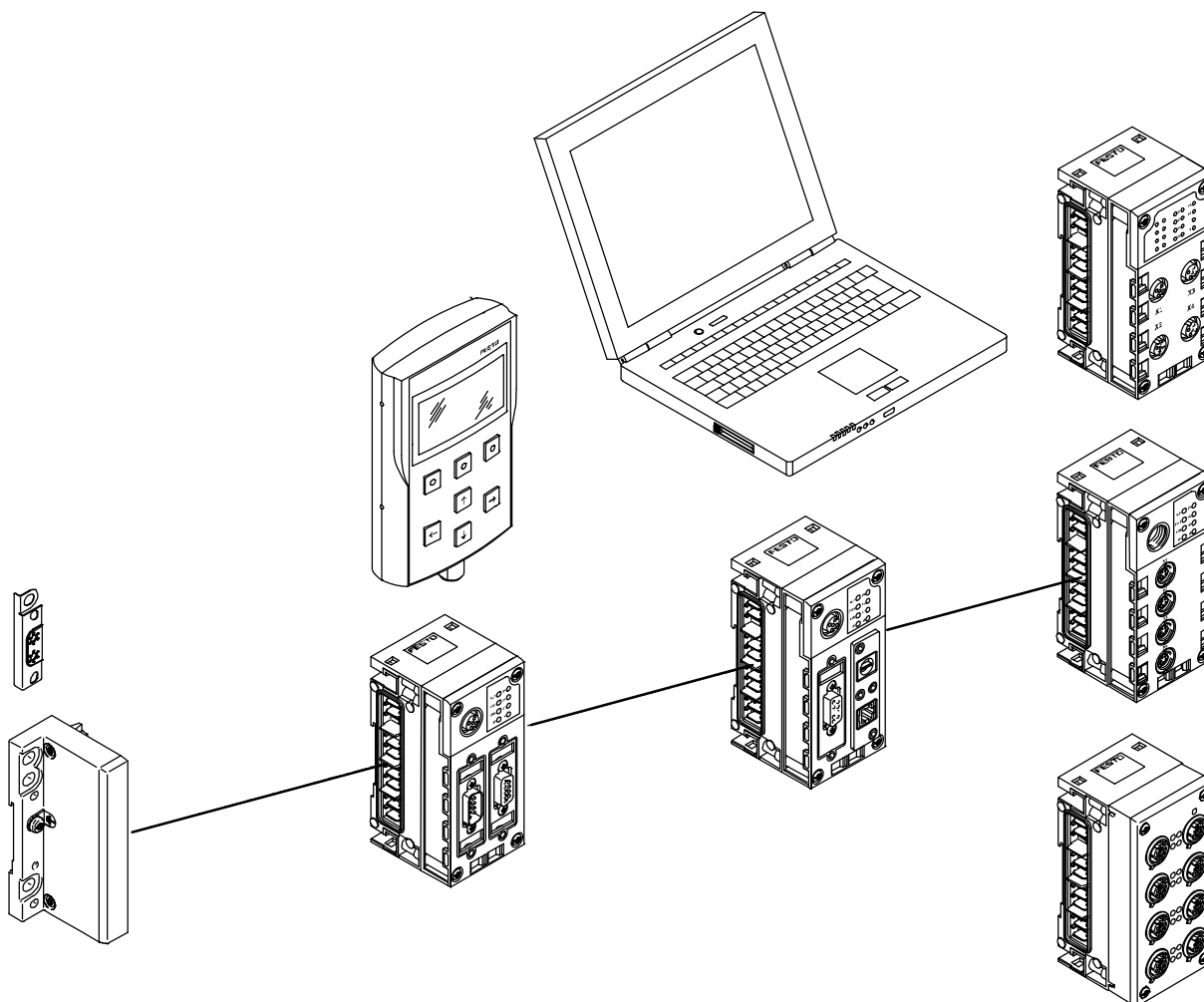
**End plate**

- Mounting holes for wall mounting
- Functional earth connection
- Special earthing plate for safe and easy connection to the machine bed or H-rail

Bus node

- Fieldbus/Industrial Ethernet connection using various types of connection technology
- Setting of fieldbus parameters via DIL switch
- Display of fieldbus and peripheral equipment status via LED
- PROFINET to AIDA standard in metal housing, fast start-up

Operator unit

- Connection to bus nodes or control block
- Display and modification of parameter settings
- Plain-text display for texts, messages (e.g. individual channel diagnostics, condition monitoring), menus, etc.

Control block

- Pre-processing, stand-alone controller or remote unit CPX-FEC-1-IE/CPX-CEC
- Connection via EtherNet TCP/IP or Sub-D programming interface
- Setting of operating modes via DIL switch and program selection via rotary switch
- CPX-CMX products for controlling axes

Web monitor

- Website integrated in the CPX terminal
- Dynamic status display
- Online diagnostics
- SMS/e-mail alert

CP interface/CTEL interface

- Interfaces for decentralised installation systems, thus optimising the pneumatic control chains (short tubes/short cycle times)
- Actuation for I/O modules and valve terminals
- Power supply and bus interface via the same cable

Input/output modules

Combination of

- Interlinking block
- Electronics module
- Connection block

Variants

Complete overview of modules

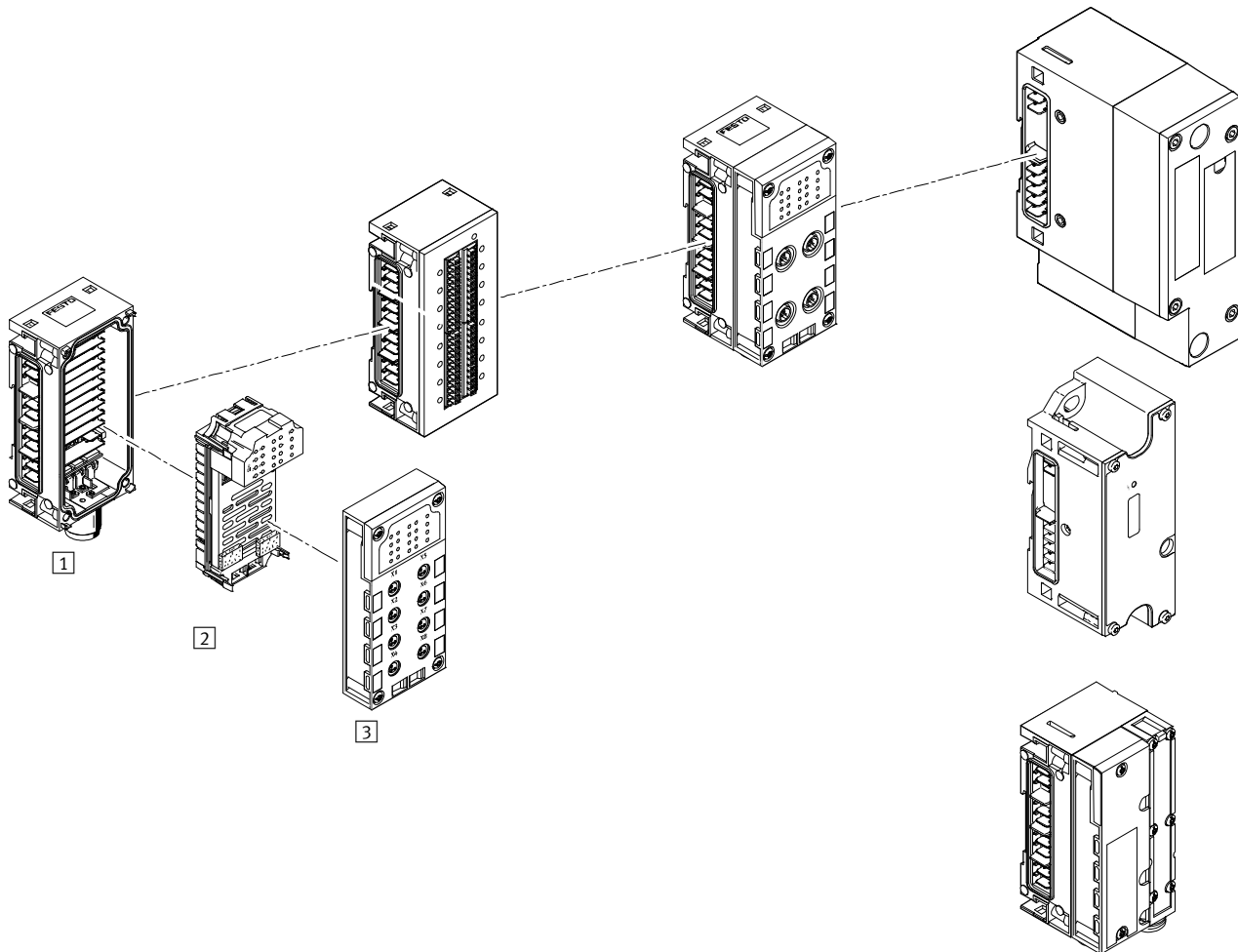

Input/output modules

1 Interlinking block

- Internal linking of the power supply and serial communication
- External power supply for the entire system
- Additional power supply for outputs or valves
- Connection accessories for M18, 7/8" or AIDA push-pull
- Polymer design: linking with tie rods
- Metal design: individual linking with M6 screws, individually expandable

2 Electronics module

- Digital inputs for connecting the sensors
- Digital outputs for activating additional actuators
- Analogue inputs
- Temperature inputs (analogue)
- Analogue outputs
- PROFIsafe shut-off module with two digital outputs for shutting off the supply voltage for valves

3 Connection block

- Choice of 8 connection technology variants
- Protection class IP65/IP67 or IP20
- Can be combined with the electronics modules
- M8/M12/Sub-D/quick connection
- M8/M12/Sub-D, etc. connecting cables
- Modular system for M8/M12 connecting cables
- M12 connection technology for the metal design

Pneumatic interface

- Actuation of the solenoid coils
- MPA-L
- VTSA/VTSA-F
- Actuation of pressure sensors
- Actuation of proportional pressure regulators

Terminal CPX

Variants

Individual overview of modules

Control block

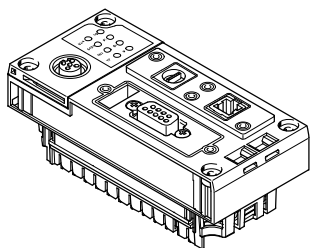

Data sheets → 1196 ff.

- CPX-FEC-1-IE
- Programming with FST
 - Ethernet interface
 - Modbus/TCP
 - EasyIP
 - Integrated web server
 - Sub-D programming interface

- CPX-CEC
- Programming with CODESYS
 - Ethernet interface
 - Modbus/TCP
 - EasyIP
 - CANopen master

Bus node

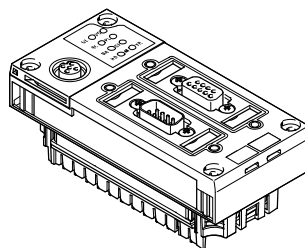

Data sheets → 1200 ff.

- Bus node for
- INTERBUS
 - DeviceNet
 - PROFIBUS DP
 - CANopen
 - CC-LINK
 - Ethernet/IP (integrated web server)
 - PROFINET (integrated web server)
 - EtherCAT

CP interface

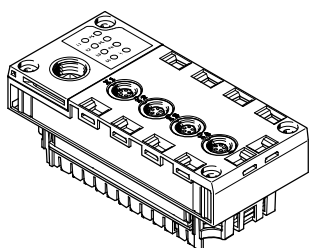

Data sheets → 1203

- CP interface
- 4 CP strings
 - Max. 4 modules per string
 - 32 inputs/32 outputs per string
 - CPI functionality

CTEL interface

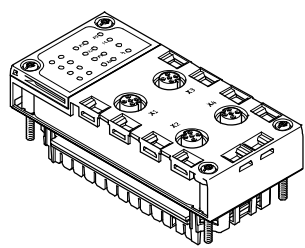

Data sheets → 1203

- CPX-CTEL interface
- CTEL master
 - Max. 4 devices with individual electronic fuse protection
 - A maximum of 64 inputs/64 outputs per I-Port interface
 - The maximum length of a string is 20 m

Modules for actuating electric drive units

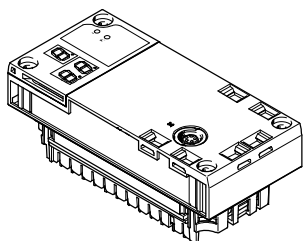

Data sheets → 1204

- CPX-CM-HPP
- Axis interface
 - CAN bus for up to 4 individual electric axes

Polymer connection block

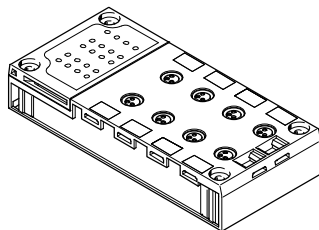

- Direct machine mounting (protection class IP65/IP67)
- M8 3-pin or 4-pin
 - M12 5-pin, 5-pin with quick lock/ metal thread screened, 8-pin, optional screening plate
 - Sub-D
 - Quick connection
 - Spring-loaded terminal with protection to IP20 or with cover

Metal connection block

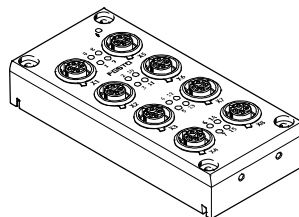

- Direct machine mounting (protection class IP65/IP67)
- M12 5-pin

Variants

Individual overview of modules

Digital electronics module

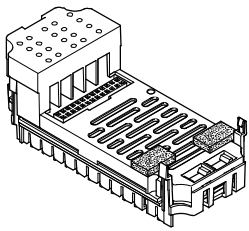

Data sheets → 1204 ff.

Digital inputs and outputs

- 8 digital inputs NPN
- 8 digital inputs PNP
- 16 digital inputs
- 16 digital inputs with channel diagnostics
- 4 digital outputs (1 A per channel, individual channel diagnostics)
- 8 digital outputs (2.1 A/50 W lamp load per channel pair, individual channel diagnostics)

Multi I/O modules

- 8 digital inputs and 8 digital outputs

Analogue electronics module

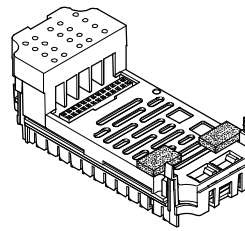

Data sheets → 1208 ff.

Analogue inputs

- 2 analogue inputs (0 ... 10 V DC, 0 ... 20 mA, 4 ... 20 mA)
- 4 analogue inputs (0 ... 20 mA, 4 ... 20 mA)

Analogue temperature inputs

- 4 analogue inputs for temperature measurement (Pt100, Pt200, Pt500, Pt1000, Ni100, Ni120, Ni500, Ni1000)
- 4 analogue inputs for temperature measurement (thermocoupler and PT1000 sensor for cold-junction compensation)

Analogue outputs

- 2 analogue outputs (0 ... 10 V DC, 0 ... 20 mA, 4 ... 20 mA)

PROFIsafe shut-off module

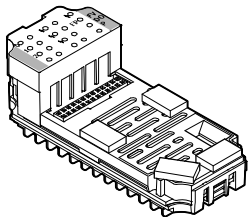

Data sheets → 1214

Digital outputs

- 2 digital outputs
- Supply voltage for valves can be shut off

Electronics module for supply ports

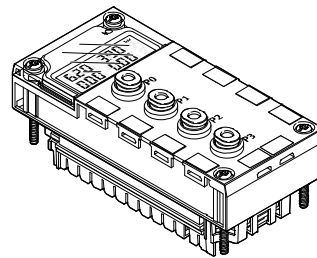

Data sheets → 1212

Analogue inputs

- 4 analogue supply ports (0 ... 10 bar, -1 ... +1 bar)

Polymer interlinking block – Interlinking by means of tie rods

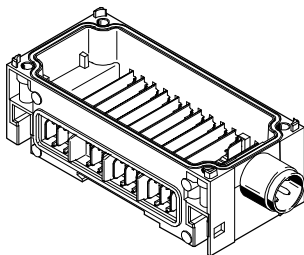

Data sheets → 1215 ff.

System linking

- Different voltages for supplying the modules
- Serial communication between the modules

System supply

- M18 4-pin
- 7/8" 4-pin or 5-pin

In addition to system linking, power supply for the

- electronics plus sensors (16 A)
- valves plus actuators (16 A)

Additional power supply

In addition to system linking, power supply for the

- actuators (16 A per supply)

Power supply for the

- valves (16 A per supply)

Expandability

- Can be expanded using an interlinking block with tie rod CPX-ZA-1-E

Note

The 7/8" supply is subject to the following restriction due to the available accessories:

- 5-pin 8 A
- 4-pin 10 A

Note

Polymer interlinking blocks (tie rods) and metal interlinking blocks (individual linking) cannot be combined due to their different interlinking systems.

Variants

Individual overview of modules

Metal interlinking block – Individual linking

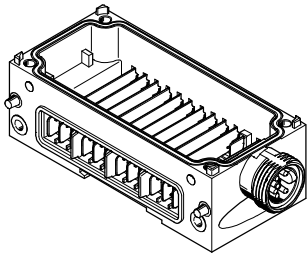

System linking

- Different voltages for supplying the modules
- Serial communication between the modules

System supply

- 7/8" 5-pin
- AIDA push-pull

In addition to system linking, power supply for the

- electronics plus sensors (16 A)
- valves plus actuators (16 A)

Additional power supply

In addition to system linking, power supply for the

- actuators (16 A per supply)

Power supply for the

- valves (16 A per supply)

Expandability

- Can be expanded as required by up to 10 interlinking blocks

Data sheets → 1215 ff.

Note

The 7/8" supply is subject to the following restriction due to the available accessories:

- 5-pin 8 A
- 4-pin 10 A

Note

Polymer interlinking blocks (tie rods) and metal interlinking blocks (individual linking) cannot be combined due to their different interlinking systems.

Pneumatic interface MPA-L

Data sheets → 1217

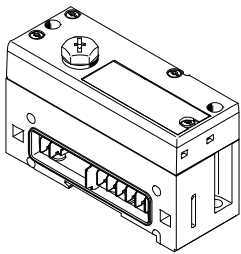

Valve terminal

- MPAL1 (360 l/min)
- MPAL14 (670 l/min)
- MPAL2 (870 l/min)
- Up to 32 solenoid coils
- For CPX polymer design

Pneumatic interface VTSA/VTSA-F

Data sheets → 1217

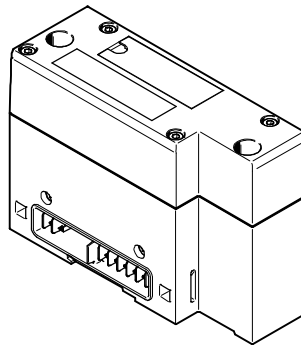

Valve terminal (valve flow rate according to width)

- 18 mm (700 l/min)
- 26 mm (1350 l/min)
- 42 mm (1300 l/min)
- 52 mm (2900 l/min)
- 65 mm (4000 l/min)
- Max. 32 valve positions/max. 32 solenoid coils
- For CPX polymer design
- For CPX metal design

Polymer end plate

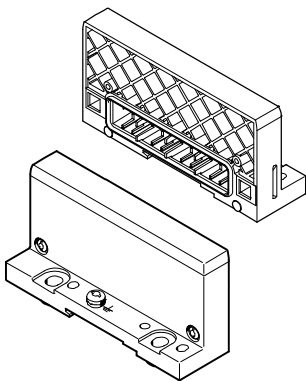

End plate

- Left-hand
- Right-hand (for use without valves)

Metal end plate

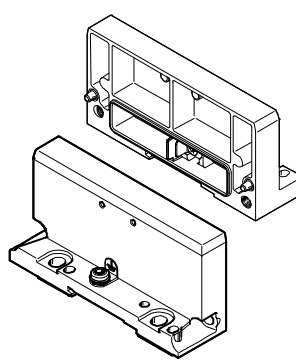

End plate

- Left-hand
- Right-hand (for use without valves)

Earthing plate (for polymer end plate)

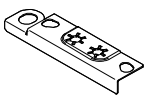

Earthing plate

- For safe and easy connection to the machine bed or H-rail, suitable for right-hand and left-hand end plate
- Assembly and earthing in a single processing step, which means:
 - 50% time saving
 - No additional material required

Data sheet

General basic data and guidelines

- Max. 11 modules in total:
- One bus node and/or one control block, freely positionable
- Up to 9 additional input/output modules, freely positionable
- An additional pneumatic interface, always positioned as the last module on the right-hand side
- With VTSA, VTSA-F and MPA-L: fixed operating range, set using switch at the pneumatic interface
- Address capacity max. 512 inputs and 512 outputs, depending on the bus node or control block
- The maximum system configuration can be limited in individual cases by exceeding the address space
- One interlinking block with system supply, freely positionable
- Multiple interlinking blocks with additional power supply, always positioned to the right of the interlinking block with system supply
- The connection blocks can, with just a few exceptions, be freely combined with the electronics modules for inputs/outputs, either in metal or polymer (→ table below)
- All electronics modules for inputs/outputs can be combined with any interlinking block
- Polymer interlinking blocks (tie rods) and metal interlinking blocks (individual linking) cannot be combined due to their different interlinking systems.

Combinations of connection blocks and digital electronics modules for inputs/outputs

Connection blocks	Digital electronics modules							
	CPX-8DE	CPX-8NDE	CPX-16DE	CPX-M-16DE-D	CPX-4DA	CPX-8DA-H	CPX-8DE-8DA	CPX-FVDA-P2
Polymer version with mounting screws for mounting on polymer interlinking blocks								
CPX-AB-8-M8-3POL	■	■	-	-	■	-	-	-
CPX-AB-8-M8X2-4POL	-	-	■	-	■	■	-	-
CPX-AB-4-M12x2-5POL	■	■	-	-	■	-	-	-
CPX-AB-4-M12x2-5POL-R	■	■	-	-	■	■	-	-
CPX-AB-8-KL-4POL	■	■	■	-	■	■	■	■
CPX-AB-1-SUB-BU-25POL	■	■	■	-	■	■	■	-
CPX-AB-4-HAR-4POL	■	■	-	-	■	-	-	-
Polymer design with mounting screws for assembly on metal plates								
CPX-AB-8-M8x2-4P-M3	-	-	■	-	■	■	-	-
CPX-AB-4-M12-8P-M3	-	-	-	-	-	-	■	-
CPX-AB-4-M12x2-5P-R-M3	■	■	-	-	■	■	-	-
Metal version with mounting screws for mounting on metal and polymer interlinking blocks								
CPX-M-AB-4-M12x2-5POL	■	■	-	-	■	■	-	■
CPX-M-AB-8-M12x2-5POL	-	-	-	■	-	-	-	-

Combinations of connection blocks and analogue electronics modules for inputs/outputs

Connection blocks	Analogue electronics modules					
	CPX-2AE-U-I	CPX-4AE-I	CPX-4AE-P	CPX-4AE-T	CPX-4AE-TC	CPX-2AA-U-I
Polymer version with mounting screws for mounting on polymer interlinking blocks						
CPX-AB-4-M12x2-5POL	■	■	-	■	■	■
CPX-AB-4-M12x2-5POL-R	■	■	-	■	■	■
CPX-AB-8-KL-4POL	■	■	-	■	■	■
CPX-AB-1-SUB-BU-25POL	■	■	-	-	-	■
CPX-AB-4-HAR-4POL	-	-	-	■	-	-
Polymer design with mounting screws for assembly on metal plates						
CPX-AB-4-M12x2-5P-R-M3	■	■	-	■	■	■
Metal version with mounting screws for mounting on metal and polymer interlinking blocks						
CPX-M-AB-4-M12x2-5POL	■	■	-	■	■	■

Technical data – Electrical terminal CPX

-  - Module width
50 mm



General technical data

Max. number of modules ¹⁾	Control block		1
	Bus node		1
	I/O modules/CP interface/CTEL interface/ electrical interface CPX-CTEL-2/multi-axis interface		9
	Pneumatic interface		1
Max. address capacity	Inputs	[byte]	64
	Outputs	[byte]	64
Configuration support			Fieldbus-specific
LED displays	Bus node/control block		Up to 4 LEDs, bus-specific 4 LEDs, CPX-specific PS = Power system PL = Power load SF = System fault M = Modify parameter/forcing active
		I/O modules	Min. one centralised diagnostic LED Channel-oriented status and diagnostic LED, depending on module
	Pneumatic interface		One centralised diagnostic LED Valve status LED on valve
Diagnostics			Channel and module-oriented diagnostics for inputs/outputs and valves
			Detection of module undervoltage for the different potential values
			Storage of the last 40 errors with timestamp (acyclic access)
Parameterisation, module-specific and entire system, for example:			Diagnostic behaviour
			Condition monitoring
			Profile of inputs
			Fail-safe response of outputs and valves
Commissioning support			Forcing of inputs and outputs
Degree of protection to EN 60529			IP65/IP67
Tests	Vibration test to DIN IEC 68		With wall mounting: severity level 2
			With H-rail mounting: severity level 1
	Shock test to DIN IEC 68		With wall mounting: severity level 2
			With H-rail mounting: severity level 1
Resistance to interference			EN 61000-6-2 (industry)
Emitted interference			EN 61000-6-4 (industry)
Grid dimension		[mm]	50

1) A maximum of 11 modules in total can be combined
(e.g. 1 control block + 9 I/O modules + 1 pneumatic interface, or 1 control block + 1 bus node + 8 I/O modules + 1 pneumatic interface)

Data sheet – Electrical terminal CPX

Download CAD data → www.festo.com

Electrical data		
Power supply	Interlinking block with system supply	
	Electronics plus sensors [V DC]	24, max. 16 A (8 A/10 A with 7/8" supply, 5-pin/4-pin)
	Actuators plus valves [V DC]	24, max. 16 A (8 A/10 A with 7/8" supply, 5-pin/4-pin)
	Additional power supply	
Actuators [V DC]		24, max. 16 A per supply (8 A/10 A with 7/8" supply, 5-pin/4-pin)
	Valves [V DC]	24, max. 16 A per supply (10 A with 7/8" supply, 4-pin)
Current consumption		Depending on system configuration
Power failure bridging (bus electronics only)	[ms]	10
Power supply connection		M18, 4-pin
		7/8" 5-pin
		7/8", 4-pin
		AIDA push-pull, 5-pin
Fuse concept		Per module with electronic fuses
Isolation test for galvanically isolated circuits to IEC 1131 Part 2	[V DC]	500
Galvanic isolation of electrical voltages	[V DC]	80
Protection against direct and indirect contact		PELV

Operating conditions

Temperature range, electronics	Operation [°C]	-5 ... +50
	Storage/transport [°C]	-20 ... +70
Temperature range, electronics plus pneumatic components	Operation [°C]	-5 ... +50
	Storage/transport [°C]	-20 ... +40

Materials

Housing	Die-cast aluminium, PA reinforced, PC
---------	---------------------------------------

Technical data – Operator unit CPX-MMI-1

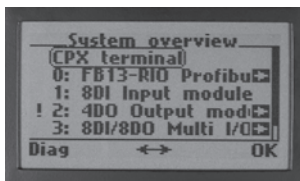

Technical data

Download CAD data → www.festo.com

Display component		LCD graphic display with background illumination (128 x 64 pixels)
Control elements		7 keys: 4 arrow keys and 3 function keys
Data interface		RS 232 interface, 57.6 kBaud, M12 socket, 4-pin
Operating voltage	[V DC]	24, supplied by the connected device
Current consumption	[mA]	50 ... 60
Length/width/height	[mm]	137/81/28

Technical data – Control block CPX-FEC-1-IE

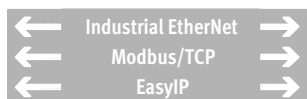

IT services:



Technical data				Download CAD data → www.festo.com
Ethernet interface				RJ45 (socket, 8-pin)
Data interface				RS232 (socket, Sub-D, 9-pin)
MMI interface				M12 socket, 5-pin
Baud rates	Ethernet interface	[Mbps]		10/100 (to IEEE802.3, 10BaseT)
	Data interface	[kbps]		9.6 ... 115.2
	MMI interface	[kbps]		56.6
Protocol				TCP/IP, Easy IP, Modbus TCP, HTTP
Flags				M0.0 ... M9999, addressable as bits or words
	Number of time flags			T0 ... T255
	Time range		[s]	0.01 ... 655.35
	Number of counting flags			Z0 ... Z255
	Counting range			0 ... 65535
Register				R0 ... R255, addressable as words
IP address setting				BOOTP/DHCP via FST or via MMI/FMT
Max. address capacity	Inputs/outputs	[byte]		64/64
	Program memory			
Program memory	User program	[kB]		250
	Web applications	[kB]		550
Programming language				IL, LD
Parameterisation		Start-up parameterisation via FST		
		Parameterisation during the operating time via functional module		
Control elements		DIL switch for setting the operating mode		
		Rotary switch for program selection/program start		
Additional functions		Storage of the last 40 errors with timestamp (access via PCP)		
		8-bit system status in image table for inputs		
		2-byte inputs and 2-byte outputs, system diagnostics in image table		
Current consumption		[mA]		Max. 200
Length/width/height (incl. interlinking block)		[mm]		107/50/55

Overview of the operating modes

	Stand-alone	Remote controller	
		Ethernet	fieldbus
CPX-FEC-1-IE function	Controller	Control and communication	
CPX module controlled by	CPX-FEC-1-IE	CPX-FEC-1-IE	
Pre-processing of data in the FEC	Yes	Yes	
Communication with higher-order controller	No	Via Ethernet • EasyIP • Modbus TCP	Via fieldbus
Web server	Possible	Possible	
Configuration	FST 4.1 or higher	FST 4.1 or higher	
Parameterisation	Via FST/CPX-MMI/CPX-FMT	Via FST/CPX-MMI/CPX-FMT	
Order code	T03	T03	
Addressing	Changeable	Changeable	
Memory	<ul style="list-style-type: none"> • 250 kB for user program • 550 kB for web applications 	<ul style="list-style-type: none"> • 250 kB for user program • 550 kB for web applications 	
CPX-MMI/-FMT	Can be connected to CPX-FEC-1-IE	Can be connected to CPX-FEC-1-IE	

Data sheet – Control block CPX-CEC



Technical data		Download CAD data → www.festo.com	
Type		CPX-CEC-C1-V3	CPX-CEC-M1-V3
Ethernet interface		RJ45 (socket, 8-pin)	
Data transmission speed	[Mbps]	10/100	
Supported protocols		TCP/IP, EasyIP, Modbus TCP	
Fieldbus interface		CAN bus (plug, Sub-D, 9-pin)	
Transmission rate	[kbps]	125, 250, 500, 800, 1000	
		Can be set using software	
Flags		28 kB remanent memory	
		CODESYS variable concept	
IP address setting		DHCP via CODESYS or via MMI	
Program memory		16 MB user program	
Programming software		CODESYS provided by Festo	
Programming language		SFC, IL, FCH, LD and ST to IEC 61131-3	
		Also CFC	
Parameterisation		CODESYS V3	
Configuration support		CODESYS V3	
Control elements		DIL switch for CAN termination	
		Rotary switch for RUN/STOP	
Function blocks		CPX diagnostic status, copy CPX diagnostic trace, read CPX module diagnostics	
		And others	
Additional functions		Diagnostic functions	
		Motion functions for electric drives	SoftMotion functions for electric drives
Total number of axes		127	31
Intrinsic current consumption at nominal operating voltage	[mA]	Typically 85	
Length/width/height (incl. interlinking block)	[mm]	50/107/55	

Data sheet – Bus node CPX-FB6



Technical data				Download CAD data → www.festo.com
Fieldbus interface				Socket and plug, Sub-D, 9-pin
Baud rates		[Mbps]		0.5 and 2
Max. number of process data bits	Inputs/outputs	[bit]		96/96
Parameterisation				Start-up parameterisation via user functions (CMD) Via PCP communication
Additional functions				Storage of the last 40 errors with timestamp (access via PCP) 8-bit system status in image table for inputs 2-byte inputs and 2-byte outputs, system diagnostics in image table
Current consumption		[mA]		Typically 200
Length/width/height (incl. interlinking block)		[mm]		107/50/55

Data sheet – Bus node CPX-FB11



Technical data				Download CAD data → www.festo.com
Fieldbus interface	Either			Micro style bus connection: 2x M12 with protection to IP65/IP67 Open style bus connection: 5-pin terminal strip, IP20
Baud rates		[kbps]		125, 250, 500
Addressing range				0 ... 63, set using DIL switch
Communication types				Polled I/O, change of state/cyclic, strobed I/O and explicit messaging
Max. address capacity	Inputs/outputs	[byte]		64/64
Parameterisation				Module and system parameterisation via configuration interface in plain text (EDS) Online in run or program mode
Additional functions				Storage of the last 40 errors with timestamp (access via EDS) 8-bit system status in image table for inputs 2-byte inputs and 2-byte outputs, system diagnostics in image table
Current consumption		[mA]		Typically 200
Length/width/height (incl. interlinking block)		[mm]		107/50/50

Data sheet – Bus node CPX-FB13

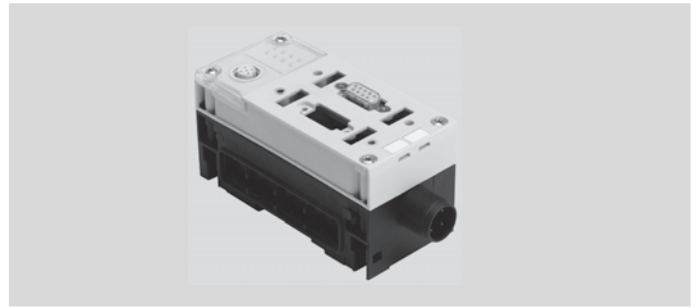

Technical data				Download CAD data → www.festo.com
Fieldbus interface				Sub-D socket, 9-pin (EN 50170), galvanically isolated 5 V
Baud rates	[Mbps]			0.0096 ... 12
Addressing range				1 ... 125, set using DIL switch
Communication types	DPV0			Cyclic communication
	DPV1			Acyclic communication
Max. address capacity	Inputs/outputs	[byte]	64/64	
Parameterisation				Start-up via configuration interface in plain text (GSD)
				Acyclic parameterisation via DPV1
Additional functions				Storage of the last 40 errors with timestamp (access via DPV1)
				8-bit system status in image table for inputs
				2-byte inputs and 2-byte outputs, system diagnostics in image table
Current consumption	[mA]	Max. 200		
Length/width/height (incl. interlinking block)	[mm]	107/50/50		

Data sheet – Bus node CPX-FB14

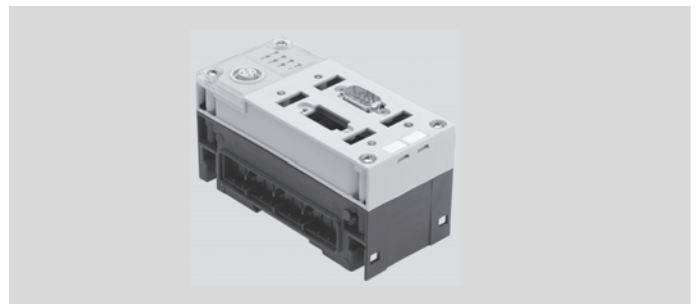

Technical data				Download CAD data → www.festo.com
Fieldbus interface				Sub-D plug, 9-pin (to DS 102), galvanically isolated via optocoupler, 24 V supply for CAN interface via bus
Baud rates	[kbps]			125, 250, 500 and 1000 can be set via DIL switch
Communication profile				DS 301, V4.01
Max. address capacity	Inputs/outputs	[byte]	16 digital, 16 analogue channels/16 digital, 16 analogue channels	
Parameterisation				Via SDO
Additional functions				Storage of the last 40 errors with timestamp (access via SDO)
				8-bit system status via transmit PDO 4 (default)
				2-byte inputs and 2-byte outputs, system diagnostics via PDO 4
				Minimum boot-up
				Variable PDO mapping
				Emergency message
				Node guarding
Current consumption	[mA]	Max. 200		
Length/width/height (incl. interlinking block)	[mm]	107/50/50		

Data sheet – Bus node CPX-FB23-24

CC-Link

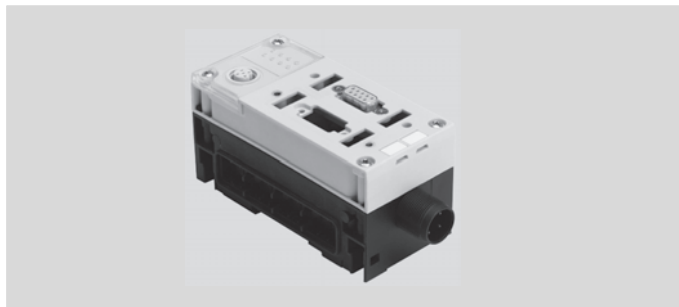
Technical data

 Download CAD data → www.festo.com

Fieldbus interface, either		Sub-D socket, 9-pin		
		Screw terminal strip, IP20		
Baud rates		[kbps]	156 ... 10000	
Number of stations per slave	1, 2, 3 or 4 stations, set using DIL switch			
Communication types	Cyclic communication			
Max. address capacity, inputs	FB23	RWr	[byte]	32
		Rx	[byte]	14
	FB24	RWr	[byte]	64
		Rx	[byte]	64
Max. address capacity, outputs	FB23	RWw	[byte]	32
		Ry	[byte]	14
	FB24	RWw	[byte]	64
		Ry	[byte]	64
Parameterisation	Hold/clear via DIL switch			
Additional functions	Storage of the last 40 errors with timestamp (access via system diagnostics)			
Current consumption		[mA]	Typically 200	
Length/width/height (incl. interlinking block)		[mm]	107/50/50	

Data sheet – Bus node CPX-FB32



IT services:

Technical data

 Download CAD data → www.festo.com

Fieldbus interface		M12 socket, 4-pin, D-coded		
Baud rates		[Mbps]	10/100, full/half duplex	
IP addressing	Via DHCP, DIL switch or network software			
Max. address capacity	Inputs/outputs	[byte]	64/64	
Parameterisation	Start-up parameterisation			
	Acyclic parameterisation via explicit messaging			
Additional functions	Storage of the last 40 errors with timestamp (access via system diagnostics)			
	8-bit system status in image table for inputs			
	2-byte I/O, system diagnostics via image table			
Current consumption		[mA]	Typically 65	
Length/width/height (incl. interlinking block)		[mm]	107 x 50 x 50	

Data sheet – Bus node CPX-FB33



Technical data		Download CAD data → www.festo.com
Fieldbus interface		2x M12 socket, 4-pin, D-coded
Baud rates	[Mbps]	100
Max. address capacity	Inputs/outputs [byte]	64/64
Parameterisation		System parameters
		Diagnostic behaviour
		Signal setup
		Fail-safe response
		Forcing of channels
Additional functions		Start-up parameterisation in plain text via fieldbus
		Fast start-up (FSU)
		Channel-oriented diagnostics via fieldbus
		Acyclic data access via fieldbus
		System status can be displayed using process data
		Additional diagnostic interface for operator units
Current consumption	[mA]	Typically 120
Length/width/height (incl. interlinking block)	[mm]	107/50/50

Data sheet – Bus node CPX-M-FB34



Technical data		Download CAD data → www.festo.com
Fieldbus interface		2x RJ45 push-pull socket, AIDA
Baud rates	[Mbps]	100
Max. address capacity	Inputs/outputs [byte]	64/64
Parameterisation		System parameters
		Diagnostic behaviour
		Signal setup
		Fail-safe response
		Forcing of channels
Additional functions		Start-up parameterisation in plain text via fieldbus
		Fast start-up (FSU)
		Channel-oriented diagnostics via fieldbus
		Acyclic data access via fieldbus
		System status can be displayed using process data
		Additional diagnostic interface for operator units
Current consumption	[mA]	Typically 120
Length/width/height (incl. interlinking block)	[mm]	107/50/80

Data sheet – Bus node CPX-M-FB35



Technical data			Download CAD data → www.festo.com
Fieldbus interface			2x SCRJ push-pull socket, AIDA
Baud rates		[Mbps]	100
Max. address capacity	Inputs/outputs	[byte]	64/64
Parameterisation			System parameters
			Diagnostic behaviour
			Signal setup
			Fail-safe response
			Forcing of channels
Additional functions			Start-up parameterisation in plain text via fieldbus
			Fast start-up (FSU)
			Channel-oriented diagnostics via fieldbus
			Acyclic data access via fieldbus
			System status can be displayed using process data
			Additional diagnostic interface for operator units
Current consumption		[mA]	Typically 150
Length/width/height (incl. interlinking block)		[mm]	107/50/80

Data sheet – Bus node CPX-FB38



Technical data			Download CAD data → www.festo.com
Fieldbus interface			2x M12x1 socket, 4-pin, D-coded
Baud rates		[Mbps]	100
Max. address capacity	Inputs/outputs	[byte]	64/64
Parameterisation			System parameters
			Diagnostic behaviour
			Signal setup
			Fail-safe response
			Forcing of channels
Additional functions			System status can be displayed using process data
			Additional diagnostic interface for operator units
Current consumption		[mA]	Typically 100
Length/width/height (incl. interlinking block)		[mm]	107/50/50

Data sheet – Interface CPX-CP-4-FB

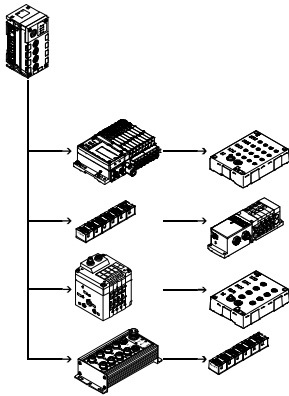

Technical data

Download CAD data → www.festo.com

CP connection			Socket M9, 5-pin
Max. number of	CP strings		4
	CP modules per string		4
	Outputs per string		32
	Inputs per string		32
Baud rate		[kbps]	1000
Sensor supply voltage		[V DC]	24 ±25% coming from bus node
Actuator load voltage		[V DC]	24 ±10% coming from bus node
Current consumption	Without CP modules	[A]	Max. 0.2
	Per CP string	[A]	Max. 1.6
Length/width/height (incl. interlinking block)		[mm]	107/50/45

Data sheet – Interface CPX-CTEL-4-M12-5POL

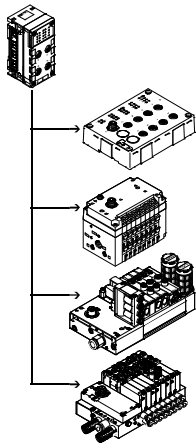

Technical data

Download CAD data → www.festo.com

I-Port connection			4x socket M12, 5-pin, A-coded
Max. address capacity	Inputs/outputs	[bit]	256/256
Number of I-Port interfaces			4
Max. cable length			[m] 20
Internal cycle time			[ms] 1 per 8 bits of user data
Additional functions			Tool change mode
Max. power supply per channel			[A] 4x 1.6
Max. residual current of outputs per channel			[A] 4x 1.6
Intrinsic current consumption at nominal operating voltage			[mA] Typically 65
Length/width/height (incl. interlinking block)		[mm]	107/50/55

Data sheet – Control block CPX-CM-HPP

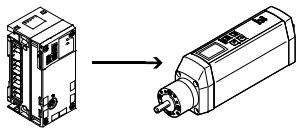

Technical data				Download CAD data → www.festo.com
Fieldbus interface		1x socket M9, 5-pin		
Control interface		CAN bus		
Baud rate	[Mbps]	1		
Protocol		FHPP		
Max. address capacity	Inputs/outputs	[byte]	32/32	
Parameterisation		Forcing of channels		
		System parameters		
Total number of axes		4		
Intrinsic current consumption at nominal operating voltage		[mA]	Typically 80	
Length/width/height (incl. interlinking block)		[mm]	107/50/55	

Data sheet – Digital input module with 8 inputs, CPX-8DE, CPX-8NDE

Possible connection blocks:

- CPX-AB-8-M8-3POL
- CPX-AB-4-M12X2-5POL
- CPX-AB-4-M12X2-5POL-R
- CPX-AB-8-KL-4POL
- CPX-AB-1-SUB-BU-25POL
- CPX-AB-4-HAR-4POL
- CPX-M-AB-4-M12X2-5POL
- CPX-M-AB-8-M12X2-5POL

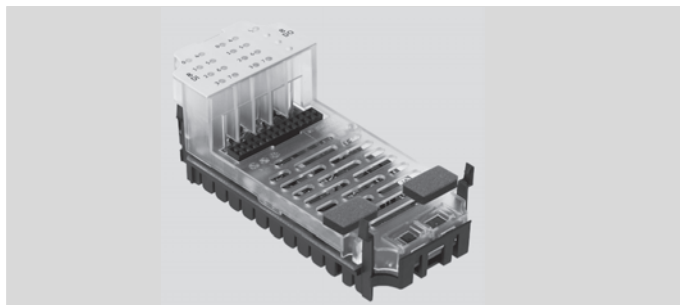

Technical data				Download CAD data → www.festo.com
Type	CPX-8DE		CPX-8NDE	
Number of inputs	8			
Max. residual current of inputs per module	[A]	1	0.7	
Internal electronic fuse		Per module	Per module	
Intrinsic current consumption at operating voltage	[mA]	Typically 15	Typically 15	
Sensor supply voltage		[V DC]	24 ±25%	
Electrical isolation	Channel – channel	No	No	
	Channel – internal bus	No	No	
Switching level	Signal 0	[V DC]	≤ 5	≥ 11
	Signal 1	[V DC]	≥ 11	≤ 5
Input characteristic		IEC 1131-T2		
Switching logic		Positive logic (PNP)		Negative logic (NPN)
Parameterisation		Module monitoring		
		Behaviour after short circuit		
		Input debounce time		
		Signal extension time		

Data sheet – Digital input module with 16 inputs, CPX-16DE, CPX-M-16DE-D

Possible connection blocks

CPX-16DE:

- CPX-AB-8-M8X2-4POL
- CPX-AB-8-M8X2-4P-M3
- CPX-AB-8-KL-4POL
- CPX-AB-1-SUB-BU-25POL

Possible connection blocks

CPX-M-16DE-D:

- CPX-M-AB-8-M12X2-5POL

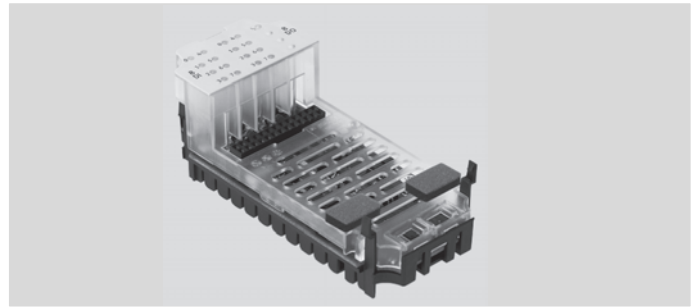

Technical data		Download CAD data → www.festo.com	
Type		CPX-16DE	CPX-M-16DE-D
Number of inputs		16	
Max. residual current of inputs per module	[A]	1.8	
Internal electronic fuse		Per module	Per channel pair
Intrinsic current consumption at operating voltage	[mA]	Typically 15	Typically 34
Sensor supply voltage	[V DC]	24 ±25%	
Electrical isolation	Channel – channel	No	
	Channel – internal bus	No	
Switching level	Signal 0 [V DC]	≤ 5	
	Signal 1 [V DC]	≥ 11	
Input characteristic		IEC 1131-2	
Switching logic		Positive logic (PNP)	
Parameterisation		Module monitoring	
		Behaviour after short circuit	
		Input debounce time	
		Signal extension time	

Data sheet – Digital output module with 4 outputs, CPX-4DA

Possible connection blocks:

- CPX-AB-8-M8-3POL
- CPX-AB-8-M8X2-4POL
- CPX-AB-8-M8X2-4P-M3
- CPX-AB-4-M12X2-5POL
- CPX-AB-4-M12X2-5POL-R
- CPX-AB-8-KL-4POL
- CPX-AB-1-SUB-BU-25POL
- CPX-AB-4-HAR-4POL
- CPX-AB-4-M12X2-5P-R-M3
- CPX-M-AB-4-M12X2-5POL

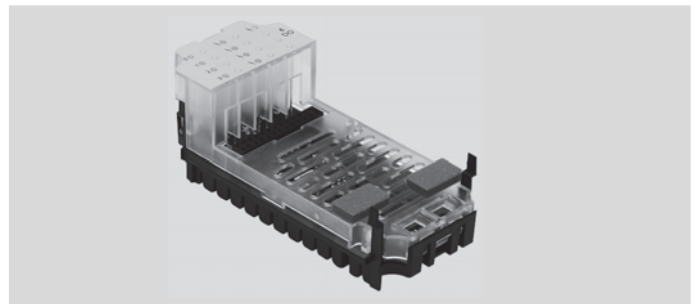

Technical data		Download CAD data → www.festo.com	
Type		CPX-4DA	
Number of outputs		4	
Max. power supply	Per module [A]	4	
	Per channel [A]	1 (24 W lamp load, 4 channels can be connected in parallel)	
Fuse protection (short circuit)		Internal electronic fuse per channel	
Module current consumption (voltage supply for electronics)	[mA]	Typically 16	
Supply voltage	[V DC]	24 ±25%	
Electrical isolation	Channel – channel	No	
	Channel – internal bus	Yes, with intermediate supply	
Output characteristic		Based on IEC 1131-2	
Switching logic		Positive logic (PNP)	
Parameterisation		Module monitoring	
		Behaviour after short circuit	
		Fail-safe channel x	
		Forcing channel x	
		Idle mode channel x	

Data sheet – Digital output module with 8 high-current outputs, CPX-8DA-H

Possible connection blocks:

- CPX-AB-8-M8X2-4POL
- CPX-AB-8-M8X2-4P-M3
- CPX-AB-4-M12X2-5POL-R
- CPX-AB-8-KL-4POL
- CPX-AB-1-SUB-BU-25POL
- CPX-AB-4-M12X2-5P-R-M3
- CPX-M-AB-4-M12X2-5POL

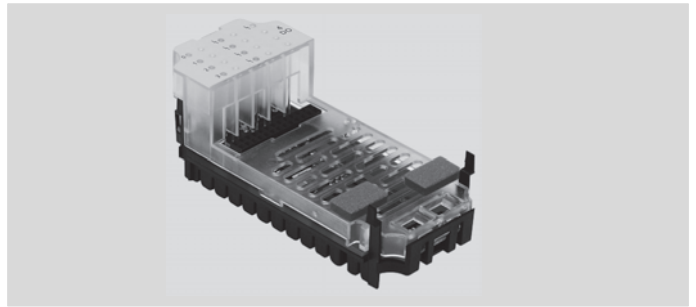

Technical data			Download CAD data → www.festo.com
Type			CPX-8DA-H
Number of outputs			8
Max. power supply	Per module	[A]	8.4
	Per channel	[A]	2.1 (50 W lamp load) per channel pair
Fuse protection (short circuit)			Internal electronic fuse per channel
Module current consumption (voltage supply for electronics)		[mA]	Typically 34
Supply voltage		[V DC]	24 ±25%
Electrical isolation	Channel – channel		No
	Channel – internal bus		Yes, with intermediate supply
Output characteristic			Based on IEC 1131-2
Switching logic			Positive logic (PNP)
Parameterisation			Module monitoring
			Behaviour after short circuit
			Fail-safe channel x
			Forcing channel x
		Idle mode channel x	

Data sheet – Digital input/output module with 8 inputs and 8 outputs, CPX-8DE-8DA

Possible connection blocks:

- CPX-AB-4-M12-8POL
- CPX-AB-4-M12-8P-M3
- CPX-AB-8-KL-4POL
- CPX-AB-1-SUB-BU-25POL

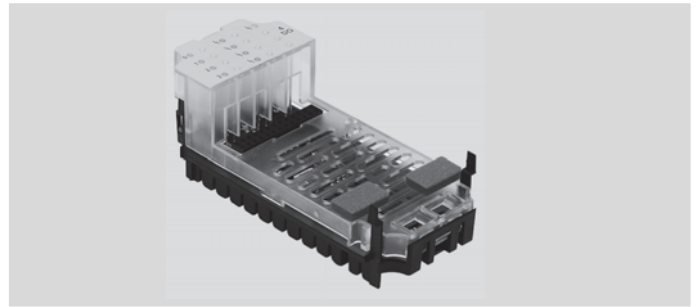

Technical data			Download CAD data → www.festo.com
Type			CPX-8DE-8DA
Number	Inputs/outputs		8/8
Max. power supply Per module	Sensor supply	[A]	0.7
	Outputs	[A]	4
Max. power supply per channel		[A]	0.5 (12 W lamp load, channels A0 ... A03 can be connected in parallel to A4 ... A7)
Fuse protection	Sensor supply		Internal electronic fuse for sensor supply
	Outputs		Internal electronic fuse per channel
Current consumption of internal electronics	Inputs/outputs	[mA]	Typically 22/typically 34
	Sensors/outputs	[V DC]	24 ±25% / 24 ±25%
Electrical isolation, inputs	Channel – channel		No
	Channel – internal bus		No
Electrical isolation, outputs	Channel – channel		No
	Channel – internal bus		Yes, with intermediate supply
Characteristic	Inputs/outputs		IEC 1131-2/IEC 1131-2
Switching logic			Positive logic (PNP)
Parameterisation	Inputs		Module monitoring
			Behaviour after short circuit, sensor supply
			Input debounce time
	Outputs		Signal stretching time, inputs
			Behaviour after short circuit
			Fail-safe channel x
			Forcing channel x
			Idle mode channel x

Data sheet – Analogue input module with 2 inputs, CPX-2AE-U-I

Possible connection blocks:

- CPX-AB-4-M12X2-5POL
- CPX-AB-4-M12X2-5POL-R
- CPX-AB-8-KL-4POL
- CPX-AB-1-SUB-BU-25POL
- CPX-AB-4-M12X2-5P-R-M3
- CPX-M-AB-4-M12X2-5POL

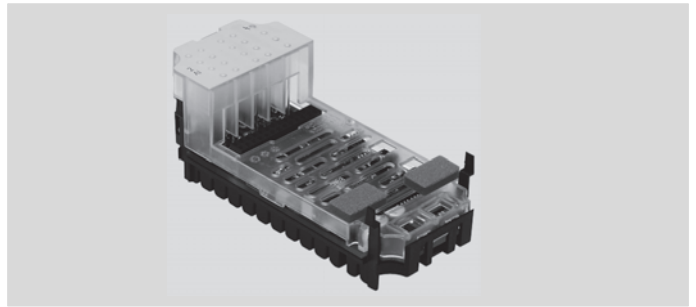

Technical data		Download CAD data → www.festo.com	
Type	CPX-2AE-U-I		
		Voltage input	Current input
Number of inputs		2	2
Max. power supply per module	[A]	0.7	0.7
Fuse protection	Internal electronic fuse for sensor supply		
Current consumption from 24 V sensor supply (quiescent current)	[mA]	Typically 50	Typically 50
Current consumption from 24 V sensor supply (at full load)	[A]	Max. 0.7	Max. 0.7
Sensor supply voltage	[V DC]	24 ±25%	24 ±25%
Signal range (parameterisable for each channel by means of DIL switch or software)		0 ... 10 V DC	0 ... 20 mA 4 ... 20 mA
Resolution	[bit]	12	
Absolute accuracy	[%]	±0.5	±0.6
Input resistance		100 kΩ	≤ 100 Ω
Max. permissible input voltage	[V DC]	30	–
Max. permissible input current	[mA]	–	40
Data format	Prefix + 15 bits, linear scaling Prefix + 15 bits left-aligned, S7 compatible Prefix + 12 bits left-aligned + diagnostics, S5 compatible		
Cable length	Max. 30 m (screened)		
Electrical isolation	Channel – channel	No	
	Channel – internal bus	Yes, with external sensor supply	
	Channel – sensor supply	Yes, with external sensor supply	
Parameterisation	Short circuit monitoring, sensor supply		
	Behaviour after short circuit, sensor supply		
	Data format		
	Lower limit value/full-scale value		
	Upper limit value/full-scale value		
	Monitoring of value falling below nominal range/full-scale value		
	Monitoring of value exceeding nominal range/full-scale value		
	Monitoring of wire break (measuring range 4 ... 20 mA)		
	Signal range		
	Measured value smoothing		

Data sheet – Analogue input module with 2 or 4 inputs, CPX-4AE-I

Possible connection blocks:

- CPX-AB-4-M12X2-5POL
- CPX-AB-4-M12X2-5POL-R
- CPX-AB-8-KL-4POL
- CPX-AB-1-SUB-BU-25POL
- CPX-AB-4-M12X2-5P-R-M3
- CPX-M-AB-4-M12X2-5POL

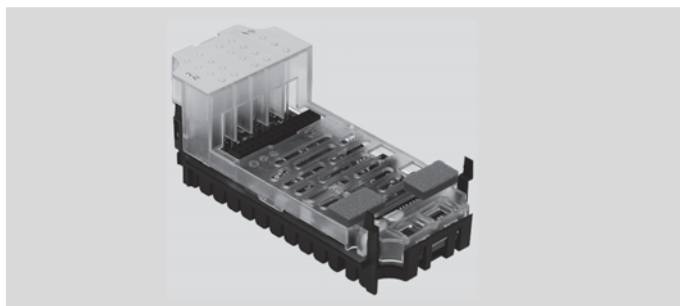

Technical data		Download CAD data → www.festo.com
Type		CPX-4AE-I
		Current input
Number of inputs		2 or 4
Max. power supply per module	[A]	0.7
Fuse protection		Internal electronic fuse for sensor supply
Current consumption from 24 V sensor supply (quiescent current)	[mA]	Typically 50
Current consumption from 24 V sensor supply (at full load)	[A]	Max. 0.7
Sensor supply voltage	[V DC]	24 ±25%
Signal range (parameterisable for each channel by means of DIL switch or software)	[mA]	0 ... 20
	[mA]	4 ... 20
Resolution	[bit]	12
Absolute accuracy	[%]	±0.6
Input resistance	[Ω]	≤ 100
Max. permissible input voltage	[V DC]	–
Max. permissible input current	[mA]	40
Data format		Prefix + 15 bits, linear scaling Prefix + 15 bits left-aligned, S7 compatible Prefix + 12 bits left-aligned + diagnostics, S5 compatible
Cable length	[m]	Max. 30 (screened)
Electrical isolation	Channel – channel	No
	Channel – internal bus	Yes, with external sensor supply
	Channel – sensor supply	Yes, with external sensor supply
Parameterisation		Short circuit monitoring, sensor supply Behaviour after short circuit, sensor supply Data format Lower limit value/full-scale value Upper limit value/full-scale value Monitoring of value falling below nominal range/full-scale value Monitoring of value exceeding nominal range/full-scale value Monitoring of wire break (measuring range 4 ... 20 mA) Signal range Measured value smoothing

Data sheet – Analogue input module with 2 or 4 inputs for temperature sensors, CPX-4AE-T

Possible connection blocks:

- CPX-AB-4-M12X2-5POL
- CPX-AB-4-M12X2-5POL-R
- CPX-AB-8-KL-4POL
- CPX-AB-4-HAR-4POL
- CPX-AB-4-M12X2-5P-R-M3
- CPX-M-AB-4-M12X2-5POL

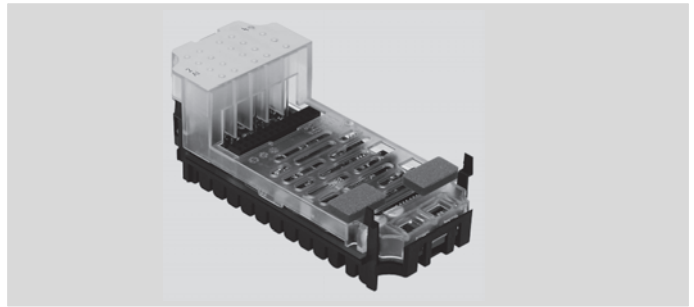

Technical data		Download CAD data → www.festo.com	
Type		CPX-4AE-T	
Number of inputs		2 or 4	
Max. power supply per module	[A]	0.7	
Fuse protection		Internal electronic fuse for sensor supply	
Current consumption from 24 V sensor supply (quiescent current)	[mA]	Typically 50	
Sensor supply voltage	[V DC]	24 ±25%	
Sensor type (parameterisable for each channel by means of DIL switch)		PT100, PT200, PT500, PT1000 Ni100, Ni120, Ni500, Ni1000	
Temperature range	Pt standard	[°C]	-200 ... +850
	Pt climatic	[°C]	-120 ... +130
	Ni	[°C]	-60 ... +180
Sensor connection technology		2-wire, 3-wire and 4-wire technology	
Resolution		[bit]	15 + prefix
Operating error limit relative to input range		[%]	±0.06
Basic error limit (25 °C)	standard	[K]	±0.6
	Pt climatic	[K]	±0.2
Temperature errors relative to input range		[%]	±0.001
Linearity errors (no software scaling)		[%]	±0.02
Repetition accuracy (at 25 °C)		[%]	±0.05
Max. line resistance per conductor		[Ω]	10
Max. permissible input voltage		[V DC]	±30
Data format		[bit]	15 + prefix, complement of two, binary notation in tenths of a degree
Cable length		[m]	Max. 200 (screened)
Electrical isolation	Channel – channel		No
	Channel – internal bus		Yes
Parameterisation			Unit of measurement and interference frequency suppression
			Diagnostic message in the event of a wire break or short circuit
			Limit monitoring per channel
			Sensor connection technology
			Sensor type/temperature coefficient, temperature range
			Limit value per channel
			Measured value smoothing

Data sheet – Analogue input module with 4 inputs for thermocoupler, CPX-4AE-TC

Possible connection blocks:

- CPX-AB-4-M12X2-5POL
- CPX-AB-4-M12X2-5POL-R
- CPX-AB-8-KL-4POL
- CPX-AB-4-M12X2-5P-R-M3
- CPX-M-AB-4-M12X2-5POL

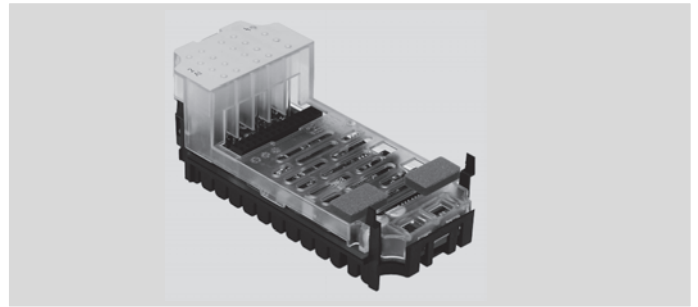
Download CAD data → www.festo.com

Technical data		CPX-4AE-TC
Type		CPX-4AE-TC
Number of inputs		4
Fuse protection		Internal electronic fuse per channel
Sensor supply voltage	[V DC]	24 ±25%
Sensor type (parameterisable for each channel by means of software)		<ul style="list-style-type: none"> • Type B +400 ... +1820 °C, 8 µV/°C • Type E -270 ... +900 °C, 60 µV/°C • Type J -200 ... +1200 °C, 51 µV/°C • Type K -200 ... +1370 °C, 40 µV/°C • Type N -200 ... +1300 °C, 38 µV/°C • Type R 0 ... +1760 °C, 12 µV/°C • Type S 0 ... +1760 °C, 11 µV/°C • Type T -200 ... +400 °C, 40 µV/°C
Sensor connection technology		2-wire technology
Operating error limit relative to ambient temperature	[%]	Max. ±0.6
Basic error limit (at 25 °C)	[%]	Max. ±0.4
Repetition accuracy (at 25 °C)	[%]	±0.05
Max. line resistance per conductor	[Ω]	10
Max. residual current per module	[mA]	30
Max. permissible input voltage	[V]	±30
Internal cycle time (module)	[ms]	250
Data format	[bit]	15 + prefix, complement of two, binary notation in tenths of a degree
Cable length	[m]	Max. 50 (screened)
Electrical isolation	Channel – channel	No
	Channel – internal bus	Yes
Diagnostics	Parameterisation error	
	Wire break per channel	
	Limit value violation per channel	
Parameterisation	Monitoring of wire break per channel	
	Unit of measurement	
	Cold-junction compensation	
	Sensor type per channel	
	Limit value monitoring per channel	
	Measured value smoothing	

Data sheet – Analogue input module with pressure sensors, CPX-4AE-P

Tubing connections:

- 4x QS4



Technical data			Download CAD data → www.festo.com	
Type			CPX-4AE-P-B2	CPX-4AE-P-D10
Number of analogue inputs			4	
Nominal operating voltage	[V DC]	24 ±25%		
Intrinsic current consumption	[mA]	Typically 50		
Measured variable	4x relative or 2x differential pressure measurement			
Displayable units	kPa			
	mbar			
	psi			
Pressure measuring range	Starting value	[bar]	-1	0
	Final value	[bar]	1	10
Data format	15 bits + prefix Binary notation in mbar, kPa, psi			
LED displays	Group diagnostics			
Diagnostics	Limit value violation per channel			
	Parameterisation error			
	Sensor limit per channel			
Parameterisation	Diagnostic delay per channel			
	Hysteresis per module			
	Unit of measurement			
	Measured value smoothing per channel			
	Limit value monitoring per channel			
	Sensor limit per channel			
Operating medium	Compressed air to ISO 8573-1:2010 [7:4:4]			
Note on operating/pilot medium	Lubricated operation possible (in which case lubricated operation will always be required)			
Temperature of medium	[°C]	0 ... +50		
Length/width/height (incl. interlinking block)	[mm]	107/50/55		

Note

Extreme pneumatic conditions, e.g. high cycle rate with high pressure amplitudes, can damage the sensors.

Data sheet – Analogue output module with 2 inputs, CPX-2AA-U-I

Possible connection blocks:

- CPX-AB-4-M12X2-5POL
- CPX-AB-4-M12X2-5POL-R
- CPX-AB-8-KL-4POL
- CPX-AB-1-SUB-BU-25POL
- CPX-AB-4-M12X2-5P-R-M3
- CPX-M-AB-4-M12X2-5POL

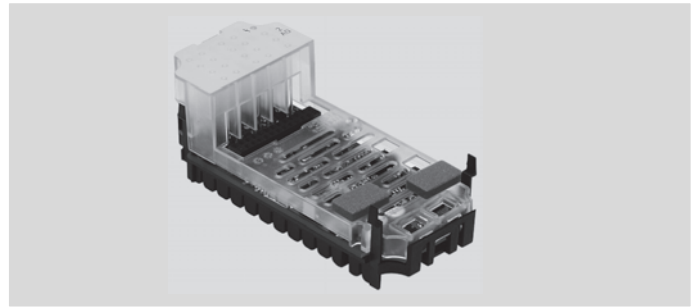

Technical data		Download CAD data → www.festo.com	
Type		CPX-2AA-U-I	
		Voltage output	Current output
Number of outputs		2	2
Max. actuator supply per module	[A]	2.8	2.8
Fuse protection		Internal electronic fuse for actuator supply	
Current consumption from 24 V sensor supply (at full load)	[mA]	Max. 150	Max. 150
Current consumption from 24 V actuator supply (at full load)	[A]	4 ... 10	4 ... 10
Supply voltage for actuators	[V DC]	24 ±25%	24 ±25%
Signal range (parameterisable for each channel by means of DIL switch or software)		0 ... 10 V DC	0 ... 20 mA 4 ... 2 mA
Resolution		12 bit	12 bit
Absolute accuracy	[%]	±0.6	±0.6
Encoder selection	Load resistance for ohmic load	[kΩ]	Min. 1
	Load resistance for capacitive load	[μF]	Max. 1
	Load resistance for inductive load	[mH]	–
	Short circuit protection for analogue output		Yes
	Short circuit current of analogue output	[mA]	Approx. 20
	Open circuit voltage	[V DC]	–
	Destruction limit against externally applied voltage	[V DC]	15
	Actuator connection		2 wires
Response time	For ohmic load	[ms]	0.1
	For capacitive load	[ms]	0.7
	For inductive load	[ms]	–
Data format		15 bits + prefix, linear scaling 12 bits left-aligned, S7 compatible 12 bits left-aligned, S5 compatible	
Cable length	[m]	Max. 30 (screened)	
Parameterisation		Short circuit monitoring, actuator supply	
		Short circuit monitoring, analogue output	
		Behaviour after short circuit, actuator supply	
		Data format	
		Lower limit value/full-scale value	
		Upper limit value/full-scale value	
		Monitoring of value falling below nominal range/full-scale value	
		Monitoring of value exceeding nominal range/full-scale value	
		Monitoring of wire break	
	Signal range		

Data sheet – PROFIsafe shut-off module, CPX-FVDA-P2

CPX-FVDA-P2

Possible connection blocks:

- CPX-M-AB-4-M12x2-5POL
- CPX-AB-8-KL-4POL

Possible bus nodes:

- CPX-FB6
- CPX-FB33
- CPX-M-FB34
- CPX-M-FB35

Possible interlinking blocks:

- CPX-M-GE-EV-FVO



Technical data		Download CAD data → www.festo.com	
Type	CPX-FVDA-P2		
Number of outputs	2		
Note on outputs	1 internal channel for shutting off the supply voltage for valves 2 external outputs		
Max. power supply	Per module	[A]	5
	Per channel	[A]	1.5
Fuse protection (short circuit)	Internal electronic fuse per channel		
Current consumption of module			[mA]
			Typically 65 (power supply for valves)
Voltage drop per channel			[mA]
			Typically 25 (power supply for electronics)
			[V]
			0.6
Residual ripple			[Vss]
			2 within voltage range
Load capacity to FE			[nF]
			400
Max. response time to shut-off command			[ms]
			23
Electrical isolation	Channel – channel	No	
	Channel – internal bus	Yes, with intermediate supply	
Switching logic	Outputs	P-M switching	
Safety integrity level	Safe Shut Off, SIL3		
Performance Level	Safe Shut Off/category 3, Performance Level e		
Diagnostics	Short circuit/overload per channel		
	Undervoltage at valves		
	Cross circuit		
	Wire break per channel		
Parameterisation	Monitoring of wire break per channel		
	Diagnostic behaviour		
Length/width/height (incl. interlinking block and connection block)	[mm]	107 x 50 x 55	

Data sheet – Interlinking block without supply, CPX-M-GE-EV-FVO

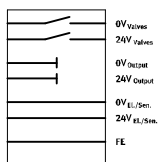

Possible modules:

- CPX-FVDA-P2



Technical data		Download CAD data → www.festo.com	
Type	CPX-M-GE-EV-FVO		
Acceptable current load (per contact/contact rail)	[A]	16	
Type of mounting	Angled fitting		
Length/width/height	[mm]	107 x 50 x 35	

Data sheet – Interlinking block with system supply, CPX-GE-EV-S, CPX-M-GE-EV-S

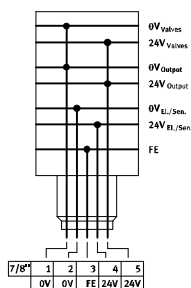

Technical data		Download CAD data → www.festo.com				
Type		CPX-GE-EV-S	CPX-GE-EV-S-7/8-4POL	CPX-GE-EV-S-7/8-5POL	CPX-M-GE-EV-S-7/8-5POL	CPX-M-GE-EV-S-PP-5POL
Electrical connection		M18	7/8", 4-pin	7/8", 5-pin	7/8", 5-pin	AIDA push-pull, 5-pin
Nominal operating voltage	[V DC]	24				
Current supply	Sensors and electronics	[A]		Max. 12	Max. 8	Max. 16
	Valves and outputs	[A]		Max. 12	Max. 8	Max. 16
Degree of protection to EN 60529		Depending on connection block				
Ambient temperature	[°C]	-5 ... +50				
Type of mounting		Tie rod			Angled fitting	
Length/width/height	[mm]	107/50/35				

Data sheet – Interlinking block without supply, CPX-GE-EV, CPX-M-GE-EV

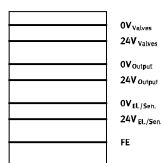

Technical data		Download CAD data → www.festo.com	
Type		CPX-GE-EV	CPX-M-GE-EV
Electrical connection		-	
Nominal operating voltage	[V DC]	24	
Acceptable current load (per contact/contact rail)	[A]	16	
Degree of protection to EN 60529		Depending on connection block	
Ambient temperature	[°C]	-5 ... +50	
Type of mounting		Tie rod	
Length/width/height	[mm]	107/50/35	

Terminal CPX

Data sheet – Interlinking block with additional power supply for outputs, CPX-GE-EV-Z, CPX-M-GE-EV-Z

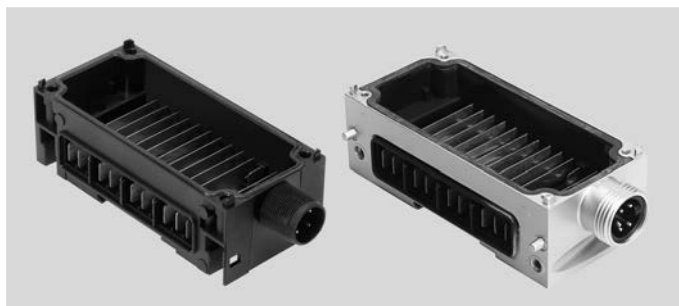
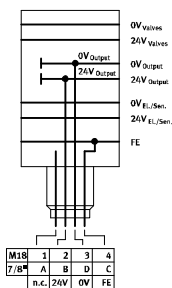

Technical data		Download CAD data → www.festo.com				
Type		CPX-GE-EV-Z	CPX-GE-EV-Z-7/8-4POL	CPX-GE-EV-Z-7/8-5POL	CPX-M-GE-EV-Z-7/8-5POL	CPX-M-GE-EV-Z-PP-5POL
Electrical connection		M18	7/8", 4-pin	7/8", 5-pin	7/8", 5-pin	AIDA push-pull, 5-pin
Nominal operating voltage	[V DC]	24				
Current supply	Outputs	Max. 16		Max. 12	Max. 8	Max. 16
Degree of protection to EN 60529		Depending on connection block				
Ambient temperature	[°C]	-5 ... +50				
Type of mounting		Tie rod			Angled fitting	
Length/width/height	[mm]	107/50/35				

Data sheet – Interlinking block with additional power supply for valves, CPX-GE-EV-V

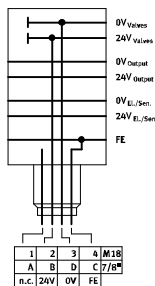

Technical data		Download CAD data → www.festo.com	
Type		CPX-GE-EV-V	CPX-GE-EV-V-7/8-4POL
Electrical connection		M18	7/8", 4-pin
Nominal operating voltage	[V DC]	24	
Acceptable current load (per contact/contact rail)	[A]	16	
Degree of protection to EN 60529		Depending on connection block	
Ambient temperature	[°C]	-5 ... +50	
Type of mounting		Tie rod	
Length/width/height	[mm]	107/50/35	

Data sheet – Pneumatic interface for valve terminal MPA-L, VMPAL-EPL-CPX

-  - Operating voltage
24 V DC



Technical data		Download CAD data → www.festo.com
Type		VMPAL-EPL-CPX
Type of mounting		Tie rod
Number of solenoid coils		32
Operating pressure	[bar]	-0.9 ... 10
Intrinsic current consumption of valve terminal (internal electronics, without valves)	At 24 V $U_{EL/SEN}$ ¹⁾	Typically 13
	At 24 V U_{val} ²⁾	Typically 35
Diagnostic message on undervoltage U_{OFF} Load voltage outside function range	[V]	17.7 ... 17.8
Nominal pick-up current/duration per solenoid coil at nominal voltage	[mA]	50/20 ms
Nominal current per solenoid coil at nominal voltage with current reduction	[mA]	10 after 20 ms
Length/width/height	[mm]	107/40/70

- 1) Power supply for electronics and sensors.
2) Load voltage supply for valves.

Data sheet – Pneumatic interface for valve terminal VTSA/VTSA-F, VABA-S6-1-X

-  - Operating voltage
24 V DC



Technical data		Download CAD data → www.festo.com
Type		VABA-S6-1-X1 VABA-S6-1-X2
Type of mounting		Tie rod Angled fitting
Number of solenoid coils		32
Electrical actuation		Fieldbus
Electrical connection		Via CPX
Nominal operating voltage	[V DC]	24
Permissible voltage fluctuations	[%]	10
Degree of protection to EN 60529		IP65
Ambient temperature	[°C]	-5 ... +50

Accessories

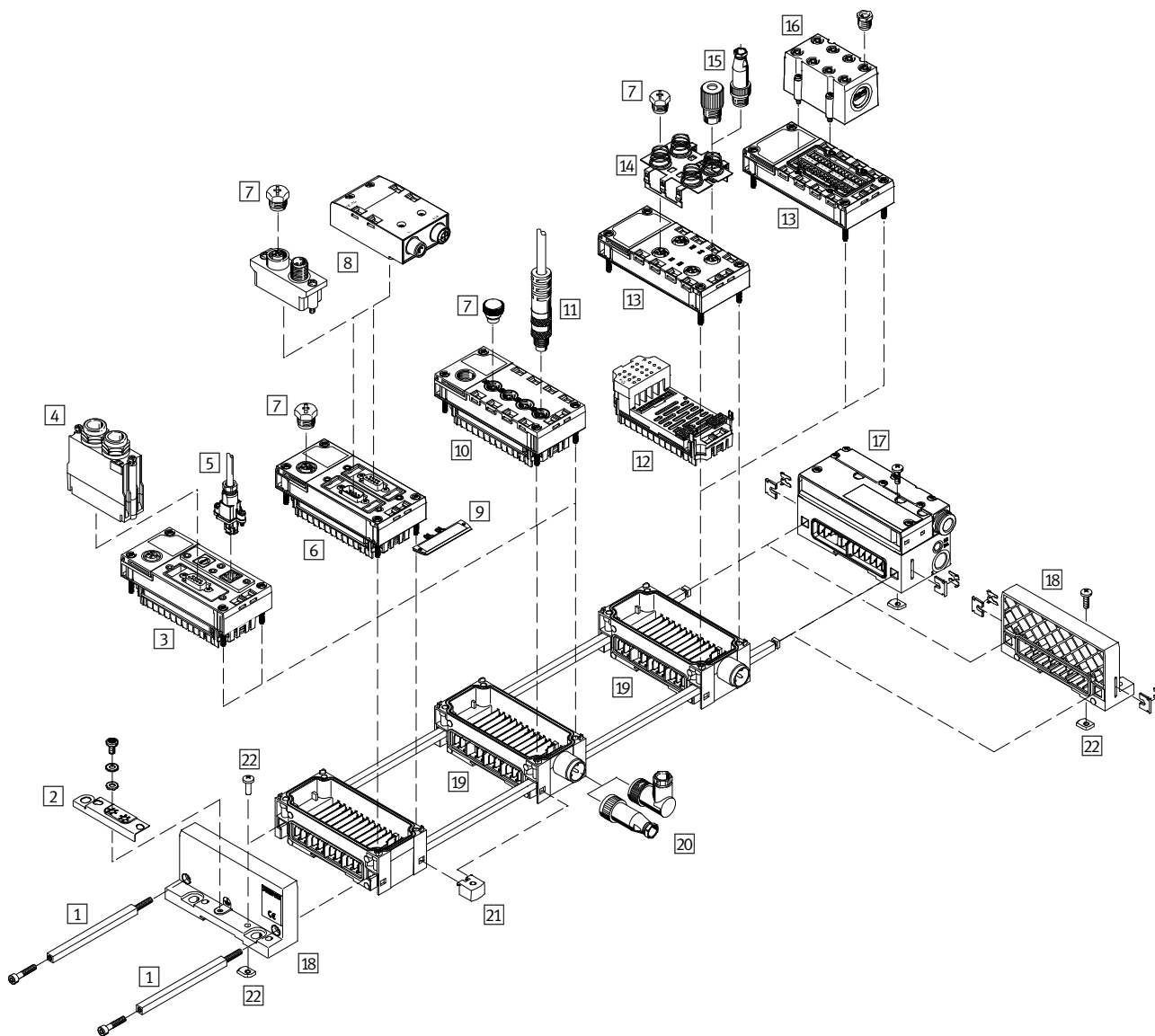







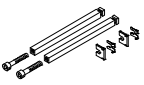
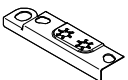
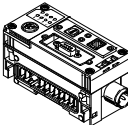
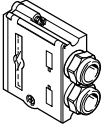
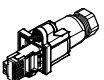
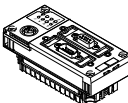

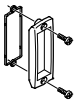

		→ Page/ online
1	Tie rod/Tie-rod extension CPX-ZA	1219
2	Earthing component CPX-EPFE-EV for right-hand/left-hand end plate	1219
3	Control block CPX-FEC-1-IE/CPX-CEC	1219
4	Plug FBS-SUB-9 for fieldbus connection (version dependent on bus type)	1219
5	Plug FBS-RJ45 for Ethernet connection	1219
6	CPX bus node CPX-FB	1219
7	Cover cap ISK/CPX-M-AK/AK-SUB (for unused connections)	1220
8	Connector plug FBA/FBS/NECU/FBSD/CPX-AB for fieldbus connection	1220
9	Inscription label IBS/CPX-ST	1221
10	CPX CP interface/CPX CTEL master/axis interface CPX-CP-4-FB/CPX-CTEL-4-M12-5POL/CPX-CM	1221
11	Connecting cable KVI-CP-3/NEBU-M12G5 for CP interface/CPX CTEL master	1221
12	CPX module CPX (analogue/digital input/output module)	1221
13	Connection block CPX-AB/CPX-M-AB	1222
14	Screening plate CPX-AB-S	1222

15	Connector plug/connecting cable KM12/NEBU/KM8/KV-M12 for inputs/outputs	1222
16	Cover for CPX-AB-8-KL-4POL (IP65/67) AK-8KL	1222
17	Pneumatic interface VMPAL-EPL-CPX/VABA-S6-1-X	1223
18	End plate CPX-EP	1223
19	Interlinking block CPX-GE/CPX-M-GE (with/without voltage supply)	1223
20	Connector plug NTSD/NECU for voltage supply	1224
21	Mounting components CPX-BG-RW/CPX-M-BG-RW for wall mounting	1224
22	H-rail mounting CPX-CPA-BG-NRH	1224
-	Hood CAFC	1224
-	Screws for mounting the bus node/connection block on an interlinking block	1224
-	Temperature sensor for CPX module CPX-4AE-TC for cold-junction compensation CPX-W-PT1000	1224
-	Memory card CPX-SK-2 for PROFINET bus node	1224
-	User documentation P.BE-CPX	1225



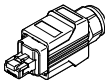
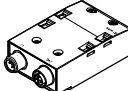

Accessories – Ordering data

	Description	Part no.	Type
1 Tie rod/tie-rod extension			
	Extension, 1 module	525418	CPX-ZA-1-E
	1 module	195718	CPX-ZA-1
	2 modules	195720	CPX-ZA-2
	3 modules	195722	CPX-ZA-3
	4 modules	195724	CPX-ZA-4
	5 modules	195726	CPX-ZA-5
	6 modules	195728	CPX-ZA-6
	7 modules	195730	CPX-ZA-7
	8 modules	195732	CPX-ZA-8
	9 modules	195734	CPX-ZA-9
10 modules	195736	CPX-ZA-10	
2 Earthing component for right/left end plate			
	5 pieces	538892	CPX-EPFE-EV
3 Control block CPX-FEC/CPX-CEC			Technical data → 1196
	With Ethernet interface RJ45	529041	CPX-FEC-1-IE
	CODESYS Embedded Controller, CANopen	3473128	CPX-CEC-C1-V3
	CODESYS Embedded Controller, SoftMotion	3472765	CPX-CEC-M1-V3
4 Plug for bus connection, Sub-D			Technical data online: → fbs
	For INTERBUS, incoming	532218	FBS-SUB-9-BU-IB-B
	For INTERBUS, outgoing	532217	FBS-SUB-9-GS-IB-B
	For DeviceNet/CANopen	532219	FBS-SUB-9-BU-2x5POL-B
	For PROFIBUS DP	532216	FBS-SUB-9-GS-DP-B
	For CC-Link	532220	FBS-SUB-9-GS-2x4POL-B
	For control block	534497	FBS-SUB-9-GS-1x9POL-B
5 Ethernet connection			Technical data online: → fbs
	RJ45 plug	534494	FBS-RJ45-8-GS
6 CPX bus node			Technical data → 1200
	INTERBUS	195748	CPX-FB6
	DeviceNet	526172	CPX-FB11
	PROFIBUS DP	195740	CPX-FB13
	CANopen	526174	CPX-FB14
	CC-Link	526176	CPX-FB23-24
	EtherNet/IP with M12	541302	CPX-FB32
	PROFINET with M12, D-coded, 4-pin	548755	CPX-FB33
	PROFINET with RJ45 push-pull, AIDA	548751	CPX-M-FB34
	PROFINET with SCRJ push-pull, AIDA	548749	CPX-M-FB35
	Bus node for EtherCAT	552046	CPX-FB38

Accessories – Ordering data

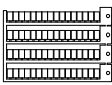
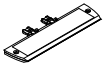
	Description	Part no.	Type
7 Cover cap			
	For M8 connections (packaging unit 10 pieces)	177672	ISK-M8
	For M12 connections (packaging unit 10 pieces)	165592	ISK-M12
	Cover cap for bus connection RJ45 Push-pull, AIDA	2873540	CPX-M-AK-D
	Cover for DIL switch and memory card	548754	CPX-M-AK-M
	Inspection cover, for DIL switch and bus connection	Transparent	533334 AK-SUB-9/15-B
		Black	557010 AK-SUB-9/15
8 Connector plug for bus connection Technical data online: → necu			
	M12 adapter (B-coded) for PROFIBUS DP	533118	FBA-2-M12-5POL-RK
	Micro style, 2x M12 for DeviceNet/CANopen	525632	FBA-2-M12-5POL
	Socket for micro style connection, M12	18324	FBSD-GD-9-5POL
	Plug for micro style connection, M12	175380	FBS-M12-5GS-PG9
	Plug M12x1, 4-pin, D-coded, for PROFINET	543109	NECU-M-S-D12G4-C2-ET
	Socket M12x1, for FBA-2-M12-5POL-RK and CPX-AB-2-M12-RK-DP	1067905	NECU-M-B12G5-C2-PB
	Plug M12x1, for FBA-2-M12-5POL-RK and CPX-AB-2-M12-RK-DP	1066354	NECU-M-S-B12G5-C2-PB
	Plug RJ45, 8-pin, push-pull	552000	FBS-RJ45-PP-GS
	Plug SCRJ, 2-pin, push-pull	571017	FBS-SCRJ-PP-GS
8 Connector plug for bus connection			
	M12 adapter for PROFIBUS DP (B-coded)	541519	CPX-AB-2-M12-RK-DP
	M12 adapter for INTERBUS (B-coded)	534505	CPX-AB-2-M12-RK-IB
	Open style for 5-pin terminal strip, for DeviceNet/CAN-open	525634	FBA-1-SL-5POL
	5-pin terminal strip, for DeviceNet/CANopen	525635	FBSD-KL-2x5POL
	Screw terminal for CC-Link	197962	FBA-1-KL-5POL

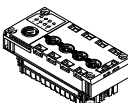
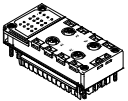
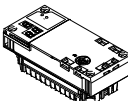
Accessories – Ordering data

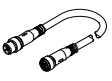
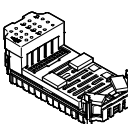
	Description	Part no.	Type
9 Inscription label			
	Inscription labels 6x10 mm, in frame (64 pieces)	18576	IBS-6x10
	Inscription label holder for connection block M12	536593	CPX-ST-1
	Screws for attaching an inscription label holder to the bus node (12 pieces)	550222	CPX-M-M2,5X8-12X
10 CPX CP interface/axis interface Technical data → 1203			
	Central node for connecting I/O modules of the CPI system	526705	CPX-CP-4-FB
	Interface for max. 4 I/O modules and valve terminals with I-Port interface (devices)	1577012	CPX-CTEL-4-M12-5POL
	For actuation of up to 4 electric drives via CAN bus	562214	CPX-CM-HPP
11 Connecting cable for CP interface, M9-M9 Technical data online: → kvi			
	Angled plug / Angled socket	0.25 m	540327 KVI-CP-3-WS-WD-0,25
		0.5 m	540328 KVI-CP-3-WS-WD-0,5
		2 m	540329 KVI-CP-3-WS-WD-2
		5 m	540330 KVI-CP-3-WS-WD-5
		8 m	540331 KVI-CP-3-WS-WD-8
	Straight plug / Straight socket	2 m	540332 KVI-CP-3-GS-GD-2
		5 m	540333 KVI-CP-3-GS-GD-5
		8 m	540334 KVI-CP-3-GS-GD-8
For CPX CTEL master, M12-M12 Technical data → 1161			
	Straight plug / Straight socket	5 m	★ 574321 NEBU-M12G5-E-5-Q8N-M12G5
		7.5 m	★ 574322 NEBU-M12G5-E-7.5-Q8N-M12G5
		10 m	★ 574323 NEBU-M12G5-E-10-Q8N-M12G5
12 CPX module Technical data → 1205			
	8 digital inputs PNP	195750	CPX-8DE
	8 digital inputs NPN	543813	CPX-8NDE
	16 digital inputs	543815	CPX-16DE
	16 digital inputs with channel diagnostics	550202	CPX-M-16DE-D
	4 digital outputs	195754	CPX-4DA
	8 digital outputs	550204	CPX-8DA-H
	8 digital inputs and 8 digital outputs	526257	CPX-8DE-8DA
	2 analogue inputs	526168	CPX-2AE-U-I
	4 analogue inputs	541484	CPX-4AE-I
	4 analogue inputs for temperature measurement	541486	CPX-4AE-T
	4 analogue inputs for temperature measurement, thermocoupler and PT1000 sensor for cold-junction compensation	553594	CPX-4AE-TC
	Input module, 4 analogue inputs (pressure), pressure range -1 ... +1 bar	560361	CPX-4AE-P-B2
	Input module, 4 analogue inputs (pressure), pressure range 0 ... 10 bar	560362	CPX-4AE-P-D10
	2 analogue outputs	526170	CPX-2AA-U-I
	PROFIsafe shut-off module	PROFINET, PROFIBUS	1971599







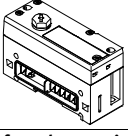
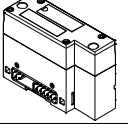
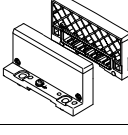
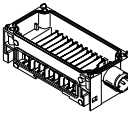
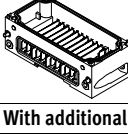
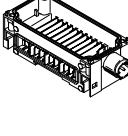
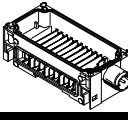



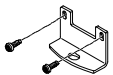

Accessories – Ordering data

	Description	Part no.	Type	
13 Connection block				
	Polymer version with mounting screws for mounting on polymer interlinking blocks			
	8x socket M8, 3-pin	195706	CPX-AB-8-M8-3POL	
	8x socket M8, 4-pin	541256	CPX-AB-8-M8X2-4POL	
	4x socket M12, 5-pin	195704	CPX-AB-4-M12x2-5POL	
	4x socket M12, 5-pin, with quick lock and metal thread	541254	CPX-AB-4-M12x2-5POL-R	
	Spring-loaded terminal, 32-pin	195708	CPX-AB-8-KL-4POL	
	1x socket, Sub-D, 25-pin	525676	CPX-AB-1-SUB-BU-25POL	
	4x socket, quick connector, 4-pin	525636	CPX-AB-4-HAR-4POL	
	Metal version with mounting screws for mounting on metal and polymer interlinking blocks			
	4x socket M12, 5-pin	549367	CPX-M-AB-4-M12x2-5POL	
8x socket M12, 5-pin	549335	CPX-M-AB-8-M12x2-5POL		
14 Screening plate				
	For M12 connections	526184	CPX-AB-S-4-M12	
15 Connector plug / Connecting cable for inputs/outputs,				
DUO connecting cable M12, 4-pin		Technical data online: → km12		
	2x straight socket	18685	KM12-DUO-M8-GDGD	
	2x straight/angled socket	18688	KM12-DUO-M8-GDWD	
	2x angled socket	18687	KM12-DUO-M8-WDWD	
Connecting cable		Technical data → 1161		
	M8-M8 3-pin/3-pin	0.5 m	175488	KM8-M8-GSGD-0,5
		1.0 m	175489	KM8-M8-GSGD-1
		2.5 m	165610	KM8-M8-GSGD-2,5
		5.0 m	165611	KM8-M8-GSGD-5
	M12-M12 5-pin/5-pin	1.5 m	529044	KV-M12-M12-1,5
		3.5 m	530901	KV-M12-M12-3,5
	M12-M12 4-pin/4-pin	2.5 m	18684	KM12-M12-GSGD-2,5
		5.0 m	18686	KM12-M12-GSGD-5
Connecting cable M9, 5-pin		Technical data online: → nebc		
	M9/open end 5-pin/5-wire	2.0 m	563711	NEBC-M9W5-K-2-N-LE3
		5.0 m	563712	NEBC-M9W5-K-5-N-LE3
16 Cover for CPX-AB-8-KL-4POL (IP65/67)				
	– 8 cable throughfeeds M9 – 1 cable throughfeed for multi-pin plug	538219	AK-8KL	
	Fittings kit for cover AK-8KL	538220	VG-K-M9	

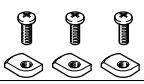
Accessories – Ordering data

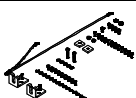
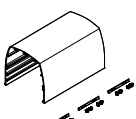
	Description	Part no.	Type	
17 Pneumatic interface, for valve terminal MPA-L				Technical data → 1217
	CPX in polymer version	570783	VMPAL-EPL-CPX	
for valve terminal VTSA/VTSA-F				
	CPX in polymer version	543416	VABA-S6-1-X1	
	CPX in metal version	550663	VABA-S6-1-X2	
18 End plates				
	Polymer version	Right-hand	195714	CPX-EPR-EV
		Left-hand	195716	CPX-EPL-EV
	Metal version	Right-hand	550214	CPX-M-EPR-EV
		Left-hand	550212	CPX-M-EPL-EV
19 Interlinking block, with system supply				Technical data → 1215
	Polymer version	M18 connection	195746	CPX-GE-EV-S
		7/8" connection, 4-pin	541248	CPX-GE-EV-S-7/8-4POL
		7/8" connection, 5-pin	541244	CPX-GE-EV-S-7/8-5POL
	Metal version	7/8" connection, 5-pin	550208	CPX-M-GE-EV-S-7/8-5POL
		Push-pull plug connection (AIDA), 5-pin	563057	CPX-M-GE-EV-S-PP-5POL
Without supply				
	Polymer version		195742	CPX-GE-EV
	Metal version		550206	CPX-M-GE-EV
	Metal version, for CPX-FVDA-P2		567806	CPX-M-GE-EV-FVO
With additional power supply for outputs				
	Polymer version	M18 connection	195744	CPX-GE-EV-Z
		7/8" connection, 4-pin	541250	CPX-GE-EV-Z-7/8-4POL
		7/8" connection, 5-pin	541246	CPX-GE-EV-Z-7/8-5POL
	Metal version	7/8" connection, 5-pin	550210	CPX-M-GE-EV-Z-7/8-5POL
		Push-pull plug connection (AIDA), 5-pin	563058	CPX-M-GE-EV-Z-PP-5POL
With additional power supply for valves				
	Polymer version	M18 connection	533577	CPX-GE-EV-V
		7/8" connection, 4-pin	541252	CPX-GE-EV-V-7/8-4POL

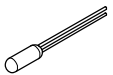
Accessories – Ordering data

	Description		Part no.	Type
20 Connector plug for power supply				
Technical data online: → ntsd				
	M18 socket, straight	For 1.5 mm ²	18493	NTSD-GD-9
		For 2.5 mm ²	18526	NTSD-GD-13,5
	M18 socket, angled	For 1.5 mm ²	18527	NTSD-WD-9
		For 2.5 mm ²	533119	NTSD-WD-11
	7/8" connection	5-pin	543107	NECU-G78G5-C2
		4-pin	543108	NECU-G78G4-C2
	AIDA push-pull plug socket, spring-loaded terminal	5-pin	563059	NECU-M-PPG5-C1
21 Attachment for wall mounting				
	For long valve terminals, 10 pieces, for polymer manifold sub-bases		529040	CPX-BG-RW-10x
	For long valve terminals, 2 mounting brackets and 4 screws, for metal manifold sub-bases		550217	CPX-M-BG-RW-2x
	Retainer for operator unit CPX-MMI-1		534705	CPX-MMI-1-H
	Mounting for H-rail for operator unit CPX-MMI-1		536689	CPX-MMI-1-NRH
22 H-rail mounting				
	For mounting CPX terminal and valve terminal on H-rail		526032	CPX-CPA-BG-NRH
Hood				
	Mounting rail for attaching the hood, 1 m		572256	CAFC-X1-S
	Mounting kit for CPX hood		572257	CAFC-X1-BE
	Hood section	200 mm	572258	CAFC-X1-GAL-200
		300 mm	572259	CAFC-X1-GAL-300
Screws for mounting the bus node/connection block on an interlinking block				
	Metal connection block, polymer interlinking block		550218	CPX-DPT-30X32-S-4X
	Polymer connection block, metal interlinking block		550219	CPX-M-M3x22-4x
	Metal connection block, metal interlinking block		550216	CPX-M-M3x22-S-4x
Temperature sensor				
	PT1000, for cold-junction compensation for CPX module CPX-4AE-TC		553596	CPX-W-PT1000
Memory card				
	For PROFINET bus node (CPX-FB33, CPX-M-FB34, CPX-M-FB35), 2MB		568647	CPX-SK-2

Accessories – Ordering data

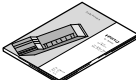
	Description	Part no.	Type
Manual			
	Bus node CPX-FB06		
	German	526433	P.BE-CPX-FB6-DE
	English	526434	P.BE-CPX-FB6-EN
	French	526436	P.BE-CPX-FB6-FR
	Italian	526437	P.BE-CPX-FB6-IT
	Spanish	526435	P.BE-CPX-FB6-ES
	Bus node CPX-FB11		
	German	526421	P.BE-CPX-FB11-DE
	English	526422	P.BE-CPX-FB11-EN
	French	526424	P.BE-CPX-FB11-FR
	Italian	526425	P.BE-CPX-FB11-IT
	Spanish	526423	P.BE-CPX-FB11-ES
	Bus node CPX-FB13		
	German	526427	P.BE-CPX-FB13-DE
	English	526428	P.BE-CPX-FB13-EN
	French	526430	P.BE-CPX-FB13-FR
	Italian	526431	P.BE-CPX-FB13-IT
	Spanish	526429	P.BE-CPX-FB13-ES
	Bus node CPX-FB14		
	German	526409	P.BE-CPX-FB14-DE
	English	526410	P.BE-CPX-FB14-EN
	French	526412	P.BE-CPX-FB14-FR
	Italian	526413	P.BE-CPX-FB14-IT
	Spanish	526411	P.BE-CPX-FB14-ES
	Bus node CPX-FB23-24		
	German	526403	P.BE-CPX-FB23-24-DE
	English	526404	P.BE-CPX-FB23-24-EN
	Bus node CPX-FB32		
	German	541304	P.BE-CPX-FB32-DE
	English	541305	P.BE-CPX-FB32-EN
	Spanish	541306	P.BE-CPX-FB32-ES
	Bus node CPX-FB33, CPX-M-FB34, CPX-M-FB35		
	German	548759	P.BE-CPX-PNIO-DE
	English	548760	P.BE-CPX-PNIO-EN
	Spanish	548761	P.BE-CPX-PNIO-ES
	Bus node CPX-FB38		
	German	562524	P.BE-CPX-FB38-DE
	English	562525	P.BE-CPX-FB38-EN
	Spanish	562526	P.BE-CPX-FB38-ES

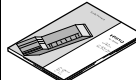
	Description	Part no.	Type
Manual			
	CPX system manual		
	German	526445	P.BE-CPX-SYS-DE
	English	526446	P.BE-CPX-SYS-EN
	Spanish	526447	P.BE-CPX-SYS-ES
	French	526448	P.BE-CPX-SYS-FR
	Italian	526449	P.BE-CPX-SYS-IT
	Operator unit CPX-MMI-1		
	German	534824	P.BE-CPX-MMI-1-DE
	English	534825	P.BE-CPX-MMI-1-EN
	French	534827	P.BE-CPX-MMI-1-FR
	Italian	534828	P.BE-CPX-MMI-1-IT
	Spanish	534826	P.BE-CPX-MMI-1-ES
	CPX CP interface		
	German	539293	P.BE-CPX-CP-DE
	English	539294	P.BE-CPX-CP-EN
	Spanish	539295	P.BE-CPX-CP-ES
	CPX CTCL master		
	German	574600	P.BE-CPX-CTCL-DE
	English	574601	P.BE-CPX-CTCL-EN
	Spanish	574602	P.BE-CPX-CTCL-ES
	Control block CPX-CM-HPP		
	German	568683	P.BE-CPX-CM-HPP-DE
	English	568684	P.BE-CPX-CM-HPP-EN
	PROFIsafe shut-off module		
	German	8022606	P.BE-CPX-FVDA-P2-DE
	English	8022607	P.BE-CPX-FVDA-P2-EN
	Spanish	8022608	P.BE-CPX-FVDA-P2-ES
	French	8022609	P.BE-CPX-FVDA-P2-FR
	Italian	8022610	P.BE-CPX-FVDA-P2-IT
	Chinese	8022611	P.BE-CPX-FVDA-P2-ZH
	Digital input/output modules		
	German	526439	P.BE-CPX-EA-DE
	English	526440	P.BE-CPX-EA-EN
	Spanish	526441	P.BE-CPX-EA-ES
	Analogue input/output modules		
	German	526415	P.BE-CPX-AX-DE
	English	526416	P.BE-CPX-AX-EN
	Spanish	526417	P.BE-CPX-AX-ES

